

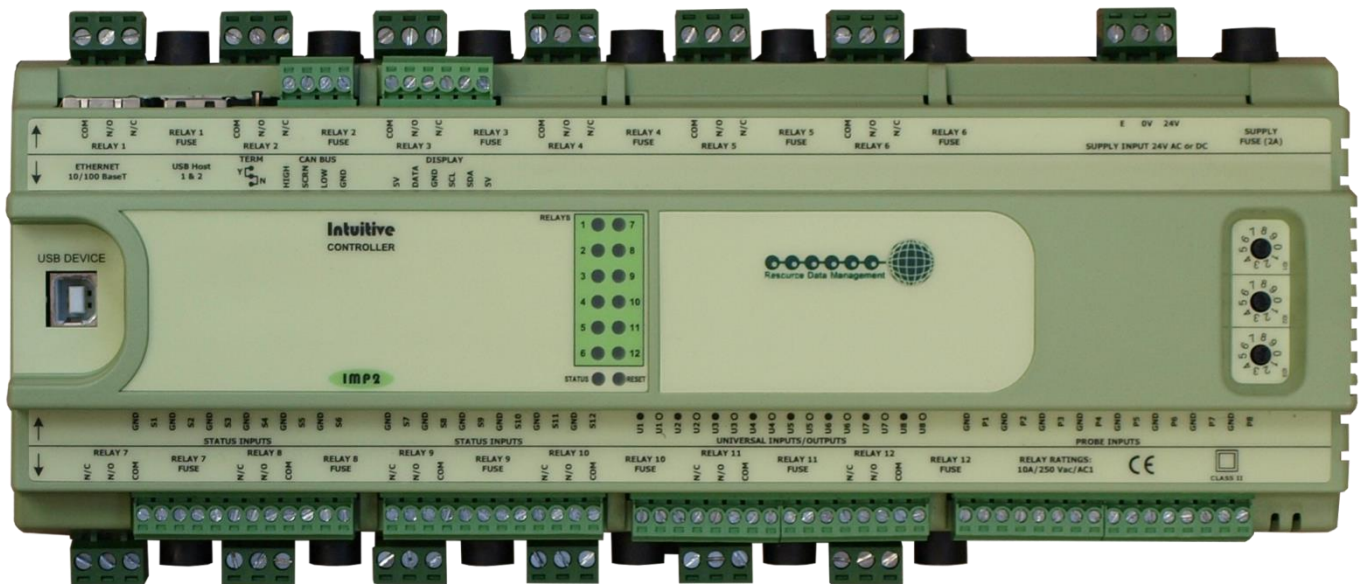

Resource
Data Management

Intuitive Circuit Controller

Commissioning/User Guide
Revision 4.2



PR065X-CCT

Contents

The Intuitive Range	5
Description	5
Part Numbers	5
Controller Display	6
Touch XL	7
Intuitive Circuit Controller, Input / Output Connections (PR0650-CCT)	8
Setting up the controller	9
Recommended set-up method	9
Set-up through front buttons	9
Display (PR0620) Menu Structure	10
Main Menu Overview (PC Connection)	11
Main Menu Overview (PC Connection) Continued	12
Intuitive Circuit Controller, Universal Analogue Input Connections	13
Inputs & Outputs	13
Main Board	13
I/O Expansion Board	13
Stepper I/O Expansion Board	13
48 Input Expansion Board	14
Set/View Probe Types & Units (Unit)	14
Set/ View Pressure Units	14
Manual Defrost (dEF)	15
Case Off (CASE)	15
Set/view controller type (type)	15
Number of Circuits (nuCr)	15
Number of Expansion Boards (nEbd)	15
Real time clock (rtc)	15
Network Configuration (nEt)	16
IP-L	16
IP-r	16
Soft	17
USB Operation	17
Touch Display Screens	17
Expansion Board Module ID	17
Parameter Table (d-01)	17
Parameter Description (d-01)	20



Please ensure all power is switched off before installing or maintaining this product.

Parameter Table (d-02)	23
Parameter Description (d-02)	24
Parameter Table (d-03)	25
Parameter Description (d-03)	25
Parameter Table (d-04)	25
Parameter Description (d-04)	25
Input and Output Allocations	26
Main Controller Board	26
IO Expansion Board PR0661	26
Stepper Expansion Board PR0660	26
48 Probe Expansion Board 662	26
Expansion Board - Communication Loss	27
48 Input Expansion Board	27
Temperature Type	27
Valve Type	27
Stepper Valve Type	28
Valve Wiring	28
Valve State – Overdriving	28
Cut-In Offset	29
OT UT Alarms	29
Defrost Termination	29
Relay and display states during defrost	29
Trim Operation	30
Intuitive Expansion Boards Universal Input / Output Connections	33
Input/Output Table	34
Override	35
Display Messages	35
Network Alarms	36
Setup via a PC	37
Control	37
Alarms	38
Visibility	38
Hardware	38
Setup	39
Mapping Summary	39
System	40
Layout	41
Maintenance	42
Remote Commands	43



Please ensure all power is switched off before installing or maintaining this product.

Specification 44

- Power requirements: 44
- General 44
- Inputs: 44
- Intuitive Circuit Controller 45
- Fuse Ratings, Intuitive Circuit Controller 45

Software, Software drivers and software features and function licences..... 45

- Clearances: 46
- Cleaning: 46
- Disclaimer 46

Appendix 1 Defrost Cycle 47

Appendix 2 – Supply & Status Input Wiring 48

Appendix 3 – BACnet object list. 49

Revision History 50



Please ensure all power is switched off before installing or maintaining this product.

The Intuitive Range

From Resource Data Management

This documentation refers to the Intuitive Plant Circuit Controller

Description

The Intuitive Plant Circuit Controller is a versatile controller intended for Circuit control applications. The controller has the ability to operate LLV's, Fans, Trim Heaters, Lights, Hot Gas Relays, Remote Relays, Stepper Motors and Defrost control. The Plant Circuit controller also provides monitoring and alarm functionality. The Plant controller CANBUS interface allows connection between the main controller and expansion boards to increase the available inputs/outputs.

The controller can be configured for up to 25 circuits.

The Plant Circuit controller, main board, has an embedded Ethernet port to allow for connection to a Data Manager system without the need for a communications module. A USB port allows for a direct PC connection amongst other features. The controller requires a 24Vac supply or a 24V dc PSU (Available from RDM: - PR0625).

Part Numbers

PR0650-CCT Intuitive Circuit Controller (Main Board), with 8 Probe Inputs, 12 Status Inputs, 8 Analogue Inputs/Outputs and 12 Relay Outputs

PR0652-CCT Intuitive Circuit Controller (Main Board), with 8 Probe Inputs, 12 Status Inputs, 8 Analogue Inputs/Outputs, 8 Relay Outputs and 2 stepper valve outputs.

PR0660 Intuitive Stepper Expansion Board, with 8 Probe Inputs, 8 Status Inputs, 8 Universal I/Os, 4 Relay Outputs and 6 Stepper Motor outputs

PR0661 Intuitive IO Expansion Board with 8 Probe Inputs, 8 Status Inputs, 8 Universal I/Os and 12 Relay Outputs

PR0662 Intuitive 48 Probe Expansion Board with 8 Universal I/Os and 48 Probe/Plant Inputs

There can be up to 10 Expansion Boards connected to the Main Board. Rotary switches on Expansion Boards select the position of the Expansion Boards. See [Expansion Board Module ID](#) for further details. For further information on all of the above expansion board variants please see RDM Plant Controller Stepper, IO & 48 Input Expansion Board User Guide on RDM Web Site.

Expansion Boards Configuration

There is no intrinsic program but all of the inputs and outputs are available for use by the Main board through the CANBUS network interface. The expansion boards cannot be accessed directly, any configuration setup or monitoring is carried out through the Main board. There is no local control within the Expansion boards. The number of Expansion boards connected and the type have to be configured in the Main board. This can be achieved through the front buttons, through a PC connection or a Data Manager front end.



Please ensure all power is switched off before installing or maintaining this product.

Controller Display

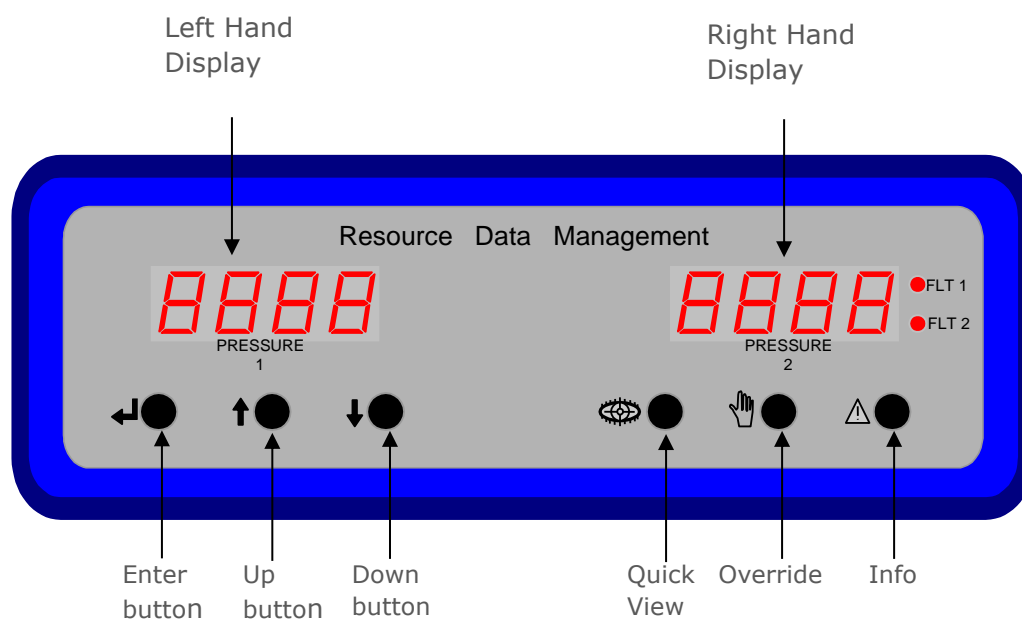

Left Hand Display

In normal operation the 4 character display shows the current Circuit number.

In set-up mode, displays the set-up menu items.

Right Hand Display

4 character display, provides the control temperature for the Circuit number currently shown on the Left Hand Display. The controller will cycle around all of the circuits configured showing the control temperature for each.

In set-up mode, display is blank.

Front Panel Buttons

Enter Button: -	Used along with Down Button to enter menu items.
Up Button: -	Used to scroll up
Down Button: -	Used to scroll down
Quick View Button: -	Not Used
Override Button: -	Used with the "Enter" button, to go into the override mode. (See Override section)
Info Button: -	Not Used

Fault LEDs are not used

Note if no Circuits are configured for use then the display will show "no Circ"



Please ensure all power is switched off before installing or maintaining this product.

Touch XL



The TouchXL when connected to the Circuit Controller, is used as a display, mimicking the view of the standard web interface to the controller. It is used to interact with the application software and alarm indication.

As default, the TouchXL will show an overview list of enabled circuits and their values such as probe inputs, Defrost, Fan, Trim outputs and control states. An optional graphical layout can be loaded onto the Circuit controller which will appear on the TouchXL. Layouts can be generated using the RDM Layout Editor software which is available separately.

The TouchXL has the benefit of being able to connect to the Intuitive device via USB (USB host 1 or 2) to micro USB or standard Ethernet connections over IP.

When connecting using the USB method, the communication of the two devices is automatic and the Touch XL will automatically configure itself for use.

Connecting over Ethernet comms requires the configuration of the TouchXL to be setup to 'look at' the Intuitive Circuit device. This can be carried out in the 'Network Configuration' page within the TouchXL service menus (only accessible directly on the touch screen). Please consult the specific documentation for more details.

Note: The TouchXL display is only compatible with Intuitive Circuit software V3.9 and above.



Please ensure all power is switched off before installing or maintaining this product.

Intuitive Circuit Controller, Input / Output Connections (PR0650-CCT)

Bottom Row Connections

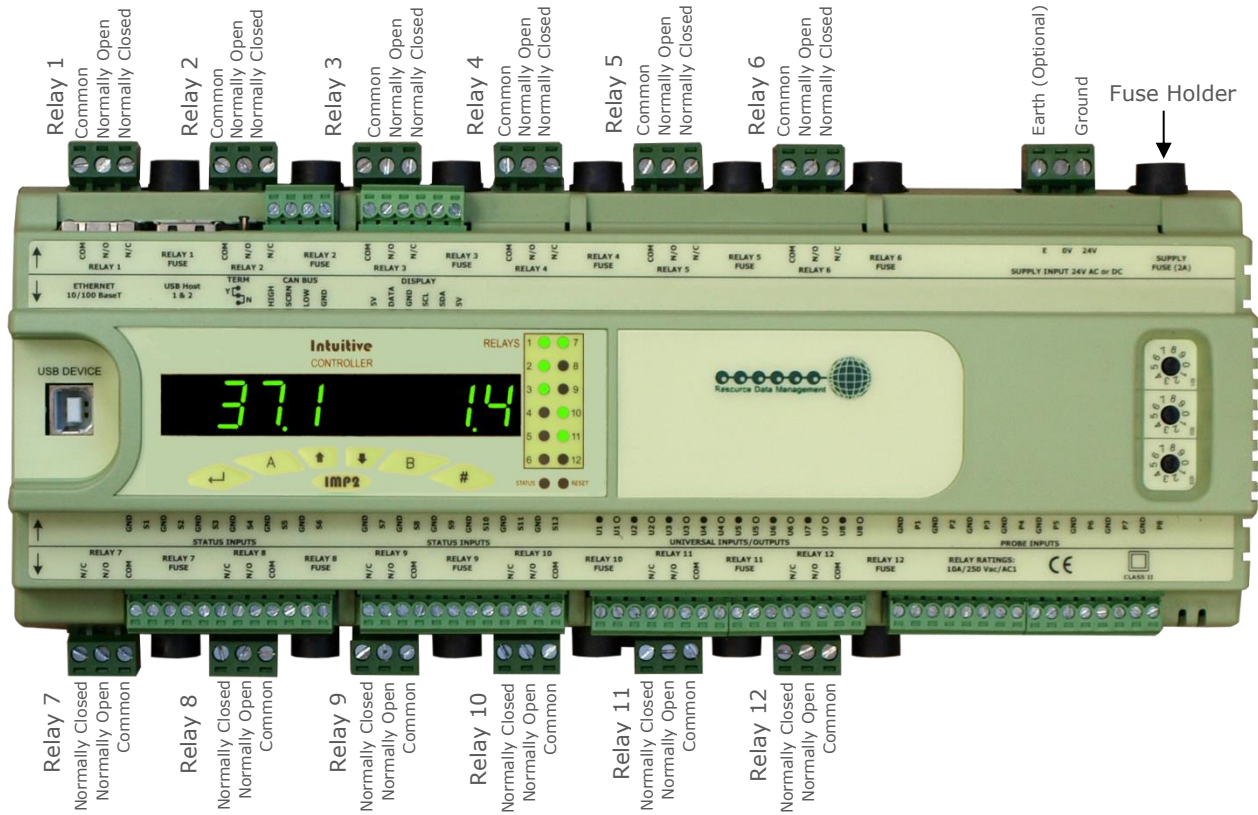

Note: The PR0652-CCT hardware variant has relays 9-12 replaced by 2 x stepper valve connections

Top Row Connections

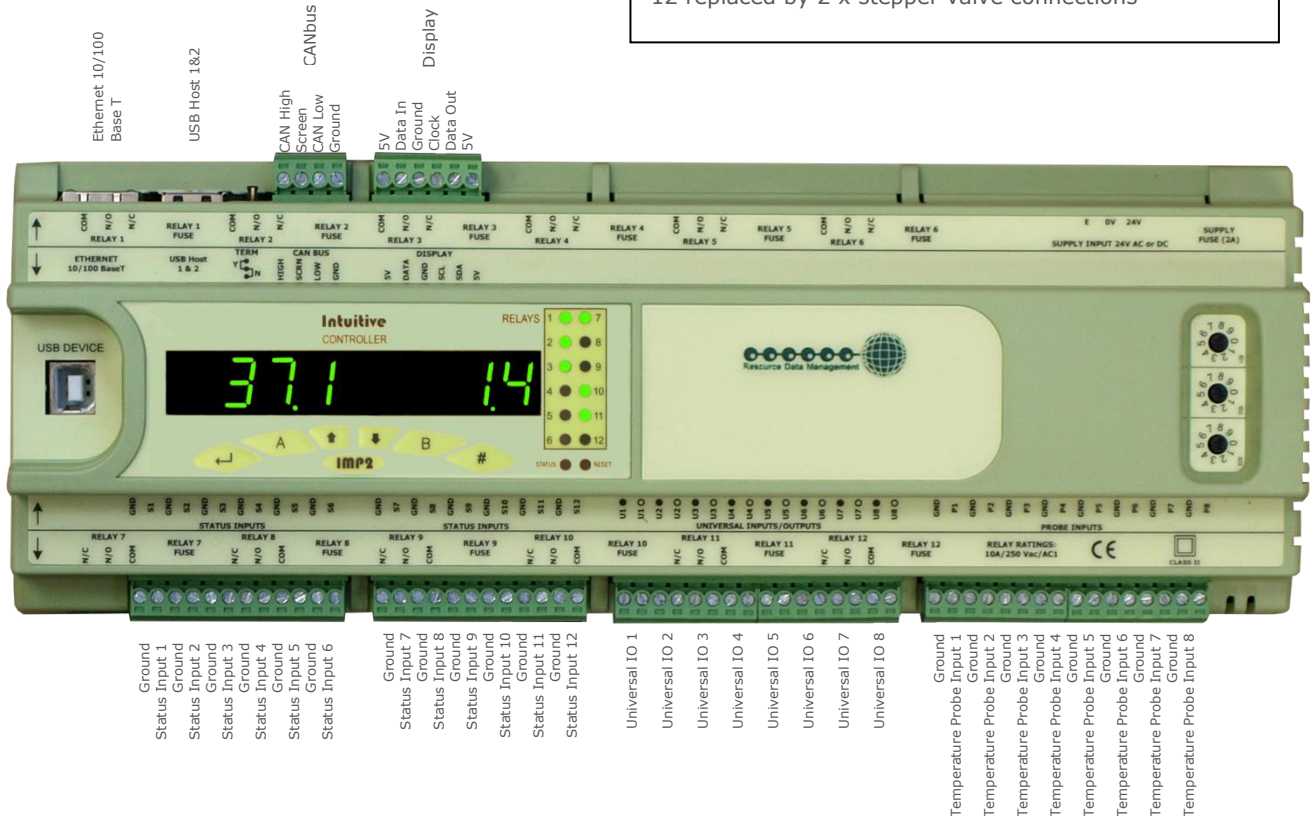

Please ensure all power is switched off before installing or maintaining this product.

Setting up the controller

Set-up access to the controller can be achieved several ways

- Through the front mounted buttons on the remote display, TouchXL or Touchscreen display.
- Direct access by PC via a USB or Ethernet connection
- Through the RDM Data Manager.*

*Note: Due to the high number of data points within the Circuit controller it is not advisable to network the controller to a Data Manager with firmware V2.0.8 or earlier. Doing so will not affect the operation of the Circuit controller but it will have an adverse effect on the Data Managers operation and therefore a Data Manager firmware update is required.

Recommended set-up method

Due to the number of parameters available, it is recommended that this controller is set-up using a direct connection to a PC See [Setup via a PC](#). If you are not connecting to a network and want to set up the controller through the buttons, below is the structure within the display's menus.

Set-up through front buttons

To enter set-up mode, hold the Enter and Down buttons together for approximately 3 seconds until the message "Ent" appears on the display. Now press the Enter button again to enter the function menu, dEty will be displayed. Scroll up or down to go through the list. Alternatively use either a PC connection for configurations or load a configuration from a memory-stick.

Set-up Menu

LH Display	LH Display	LH Display	LH Display	Option	Explained in Paragraph
dEty	→ If Selected				
	d-0x (d-01 to d-04) x = Device Number	→ If selected		Select Device to view/change	Device Number
		dS0x (dS01 0o dS03) x = Section Number	→ If selected	Select Section to view/change	Section Number
			IO	View Input/ Output States	View Input/ Output States
			PARA	Set/view Parameters	Set/view parameters
	← ESC	← ESC	← ESC	Exit Menu	
Unit				Set/View Probe Type & Units	Set/View Probe Type & Units
Pres				Set/View Pressure Units	Set/View Pressure Unit
dEf				Select Circuit to go on Defrost	Manual Defrost
CASE				Set/View Circuit to Case Off	Case Off
TyPE				Set/View Controller Type	Set/view device type
nuCr				Set/View Number of Circuits	Set/view number of Circuits
nEbd				Set/View Number of Expansion Boards	Set/view number of Expansion Boards
rtc				Set/view Clock (rtc = Real Time Clock)	Real Time Clock
nEt				Set/view network configuration	Network Configuration
SoFt				View software version	Software
USb				Save/Load onto USB device	USB Operation
Scrn				Viewed on mini touch display	Touch Display Screens
ESC				Exit set-up mode	



Please ensure all power is switched off before installing or maintaining this product.

Display (PR0620) Menu Structure

Hold the Enter and Down keys for 3 seconds then press Enter

Text, as it appears on the display, is shown in green.
Parameter description is shown in blue.

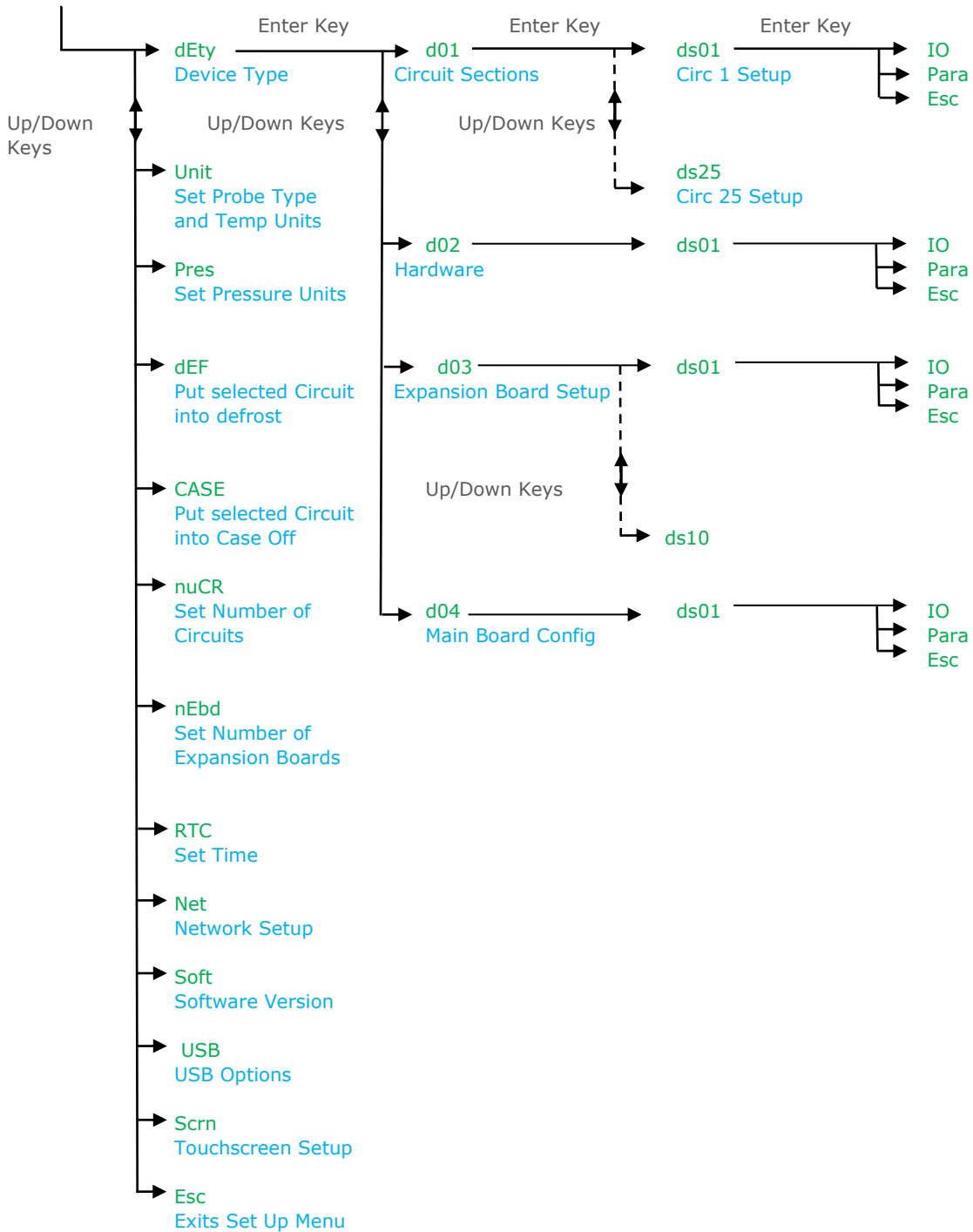

Device Selection

There are 4 devices that can be viewed / set up in the dEty menus.

- d-01** (Circuits) Circuits 1-25, view I/O and set parameters (dS01 to dS25)
- d-02** (U Dev) For Hardware configuration, view I/O and set parameters (dS01)
- d-03** (Ext Boards) Sections 1 - 10, view I/O and set parameters (dS01 to dS10)
- d-04** (Main Board) For Main Board configuration, view I/O and set parameters (dS01)



Please ensure all power is switched off before installing or maintaining this product.

Main Menu Overview (PC Connection)

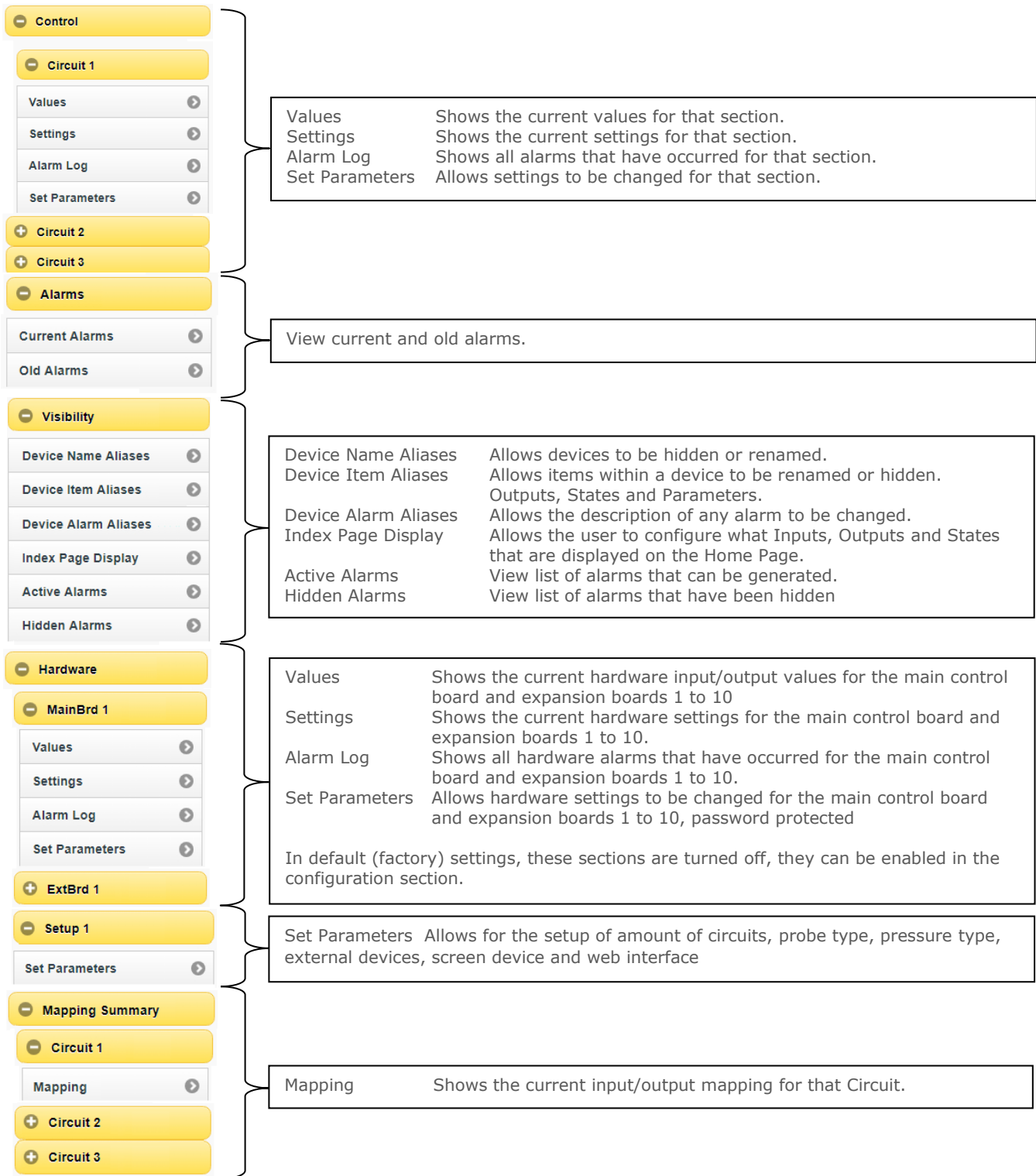

Please ensure all power is switched off before installing or maintaining this product.

Main Menu Overview (PC Connection) Continued.

<ul style="list-style-type: none"> System System Log Mute All Alarms Clear Alarm Logs Clear Aliases Features Network Time Version TouchXL Status 	<table border="1"> <tr> <td>System Log</td> <td>View system log</td> </tr> <tr> <td>Mute All Alarms</td> <td>Silences all alarms</td> </tr> <tr> <td>Clear Alarm Logs</td> <td>Removes the alarm log</td> </tr> <tr> <td>Clear Aliases</td> <td>Clears all aliases that have been assigned IO. Additionally clears the visibility of sections and IO's and will reset the visibility on the display to default.</td> </tr> <tr> <td>Features</td> <td>Shows current features enabled.</td> </tr> <tr> <td>Network</td> <td>Shows current set up: - Rotary switches, IP address, Netmask & Default gateway.</td> </tr> <tr> <td>Time</td> <td>Set the Time or synchronise with the PC</td> </tr> <tr> <td>Version</td> <td>Shows the controller and expansion board's software version</td> </tr> <tr> <td>TouchXL Status</td> <td>Shows IP Address, MAC address, name, connection status details.</td> </tr> </table>	System Log	View system log	Mute All Alarms	Silences all alarms	Clear Alarm Logs	Removes the alarm log	Clear Aliases	Clears all aliases that have been assigned IO. Additionally clears the visibility of sections and IO's and will reset the visibility on the display to default.	Features	Shows current features enabled.	Network	Shows current set up: - Rotary switches, IP address, Netmask & Default gateway.	Time	Set the Time or synchronise with the PC	Version	Shows the controller and expansion board's software version	TouchXL Status	Shows IP Address, MAC address, name, connection status details.
System Log	View system log																		
Mute All Alarms	Silences all alarms																		
Clear Alarm Logs	Removes the alarm log																		
Clear Aliases	Clears all aliases that have been assigned IO. Additionally clears the visibility of sections and IO's and will reset the visibility on the display to default.																		
Features	Shows current features enabled.																		
Network	Shows current set up: - Rotary switches, IP address, Netmask & Default gateway.																		
Time	Set the Time or synchronise with the PC																		
Version	Shows the controller and expansion board's software version																		
TouchXL Status	Shows IP Address, MAC address, name, connection status details.																		
<ul style="list-style-type: none"> Network BACnet/RDM-485 Setup 	<p>Allows the user to alter the BACnet configuration of the controller.</p>																		
<ul style="list-style-type: none"> Layout Manage Layouts 	<p>Allows the user to upload, configure, download, remove and preview layouts on the controller.</p>																		
<ul style="list-style-type: none"> Maintenance Main Config Save Config Load Config View Config Info Add Feature Reset 	<table border="1"> <tr> <td>Main Config</td> <td>Shows the current configuration of the controller.</td> </tr> <tr> <td>Save Config</td> <td>Saves the current Configuration</td> </tr> <tr> <td>Load Config</td> <td>Allows the user to upload a previously saved configuration, NOTE: file needs to be named "Setup.xml"</td> </tr> <tr> <td>View Config Info</td> <td>Shows details on the last loaded config including any unmatched items dues to differences in firmware.</td> </tr> <tr> <td>Add Feature</td> <td>Shows the system key to allow features to be enabled remotely.</td> </tr> <tr> <td>Reset</td> <td>Allows the user to reset the controller.</td> </tr> </table>	Main Config	Shows the current configuration of the controller.	Save Config	Saves the current Configuration	Load Config	Allows the user to upload a previously saved configuration, NOTE: file needs to be named "Setup.xml"	View Config Info	Shows details on the last loaded config including any unmatched items dues to differences in firmware.	Add Feature	Shows the system key to allow features to be enabled remotely.	Reset	Allows the user to reset the controller.						
Main Config	Shows the current configuration of the controller.																		
Save Config	Saves the current Configuration																		
Load Config	Allows the user to upload a previously saved configuration, NOTE: file needs to be named "Setup.xml"																		
View Config Info	Shows details on the last loaded config including any unmatched items dues to differences in firmware.																		
Add Feature	Shows the system key to allow features to be enabled remotely.																		
Reset	Allows the user to reset the controller.																		



Please ensure all power is switched off before installing or maintaining this product.

Intuitive Circuit Controller, Universal Analogue Input Connections

Terminal	Description
U1-U8 ●	0 or 4-20mA Loop Input or 0-10V Ground
U1-U8 ○	12v 4-20mA Transducer Feed or 0-10V Input

Inputs & Outputs

Main Board

	Description	Comments
Digital Input 1 to 12	0V return or 24 Vac	Note 1
Analogue Input 1 to 8	Thermistor Probe input	Note 2
Variable Input 1 to 8	Analogue input	4-20mA or 0-10V Input Note 3
Relay 1 to 12	N/O, N/C and Common	Volt Free
Steppers 1 to 2	Bi Polar Stepper Motor	Only on PR0652 Hardware option.
Status LED	Healthy LED	When powered up and operating the LED will flash off/on every 0.5 seconds.

Note 1: 24 Vac must have the same 24 Vac return as the supply voltage. If using the Circuit controller 24V power supply only the 24Vac signal from the supply is required for the digital input. If using an external 24V power supply to signal a status change then both a common (0V) and status input signal (24V) is required for the appropriate digital input.

Note 2: Several probe types are available, see [Probe Type](#)

Note 3: Variable Input default is 0-10v, variable outputs are not used in the circuit controller.

I/O Expansion Board

All Types	Description	Comments
Digital Input 1 to 8	0V return or 24 Vac	Note 1
Analogue Input 1 to 8	Temperature Probe input	Note 2
Universal I/O 1 to 8	Analogue Input	See Universal IO
Relay 1 to 12	N/O, N/C and Common	Volt Free
Module ID	Position 0 through to 9	Select a unique ID for each expansion board in use. See Expansion Board Module ID
Status LED	Healthy LED	When powered up and operating the LED will flash off/on every 0.5 seconds.

Stepper I/O Expansion Board

All Types	Description	Comments
Digital Input 1 to 8	0V return or 24 Vac	Note 1
Analogue Input 1 to 8	Temperature Probe Input	Note 2
Universal I/O 1 to 8	Analogue Input	See Universal IO
Relay 1 to 4	N/O, N/C and Common	Volt Free
Stepper Output 1 to 6	Out1B, Out1A, Out2A and Out 2b	Bipolar stepper motor
Module ID	Position 0 through to 9	Select a unique ID for each expansion board in use. See Expansion Board Module ID
Status LED	Healthy LED	When powered up and operating the LED will flash off/on every 0.5 seconds.



Please ensure all power is switched off before installing or maintaining this product.

48 Input Expansion Board

All Types	Description	Comments
Analogue Input 1 to 48	Probe input / Plant Fault	See 48 Input Expansion board Additional Setup
Universal I/O 1 to 8	Analogue Input	See Universal IO
Module ID	Position 0 through to 9	Select a unique ID for each expansion board in use. See Expansion
Status LED	Healthy LED	When powered up and operating the LED will flash off/on every 0.5 seconds.

Universal IO

Each universal IO can be set as the following: -
0-10 Volts DC, 0-5 Volts DC, 0.5-4.5 Volts DC, 0.5-9.5 Volts DC, 1-2 Volts DC or 1-6 Volts DC Input or 4-20mA Input (4-20mA current loop, use the 12 Vdc output to feed the 4-20mA device.).

Although the universal IO can be set to mA or voltage outputs these are not currently used in the Circuit controller variant.

Please refer to [Expansion Board Type](#) to configure each universal IO.

Set/View Probe Types & Units (Unit)

Probe type changes affect all probe inputs. This option allows the user to set the probe types and units.

- Use the up or down buttons to Navigate to the menu option **Unit** and press enter.
- The current unit number will be shown. Use the Up arrow to scroll to the desired unit number from the table below.
- Press Enter to save the desired unit number and exit back into the software menu.

Unit Number	Probe Type	Units	Unit Number	Probe Type	Units
0	Probes not used				
1	PT1000	°C	12	NTC2K25	°F
2	PT1000	°F	13	NTC100K	°C
3	NTC2K	°C	14	NTC100K	°F
4	NTC2K	°F	15	NTC5K	°C
5	NTC470R	°C	16	NTC5K	°F
6	NTC470R	°F	17	NTC6K	°C
7	NTC700R	°C	18	NTC6K	°F
8	NTC700R	°F	19	NTC10K T1	°C
9	NTC3K	°C	20	NTC10K T1	°F
10	NTC3K	°F	21	NTC10K T2 (USA NTC10K)	°C
11	NTC2K25	°C	22	NTC10K T2 (USA NTC10K)	°F

Temperature probe range -60 to 128 (-76 to 262) Degrees Celsius (Fahrenheit)

Set/ View Pressure Units

This option allows the user to set the pressure units to Bar or PSI.

Select the pressure displayed using the steps outlined below.

- Use the up or down buttons to Navigate to the menu option '**PrES**' and press enter.
- Use the Up and down arrows to select 0 (Bar) or 1 (PSI). By default the number of Circuits enabled is
- Press Enter to save the change and return into the main software menu.



Please ensure all power is switched off before installing or maintaining this product.

Manual Defrost (dEF)

Used to force a circuit into defrost (Manual defrost).

- d) Use the up or down buttons to Navigate to the menu option **dEF** and press enter.
- e) A list of defrost channels for all circuits currently configured is shown. d-01 is circ 1, d-02 is circ 2 etc.
- f) Scroll to the desired defrost channel and press enter.
- g) The value 0 will be shown. Use the up arrow to change this to 1 and press enter. The corresponding circuit will now start a defrost cycle.

Note the option **dALL** will instruct every circuit to go into defrost. Use with caution.

Case Off (CASE)

Used to place a selected circuit into a case off state. Note whilst a circuit is in case off all control processes are turned off and no alarms are generated.

- a) Use the up or down buttons to Navigate to the menu option **CASE** and press enter.
- b) From here a list of all the circuits currently enabled are shown, for example C-01, C-02 etc.
- c) Scroll to the desired circuit and press enter.
- d) Use the up arrow to change the value from 0 to 1 and press enter. The corresponding circuit will now be placed into the case off state.
- e) To take a circuit out of case off repeat the above process and change the 1 to a 0.

If the controller is reset or powered off/on any circuit which is in case off will return to normal operation.

Note the option **dALL** will instruct every circuit to go into case off. Use with extreme caution.

Set/view controller type (type)

- a) Currently there is only one type for this controller

Number of Circuits (nuCr)

Select the number of circuits that are required using the steps outlined below.

- h) Use the up or down buttons to Navigate to the menu option **nuCR** and press enter.
- i) The current number of circuits configured is shown. Use the Up arrow to scroll to the required number of circuits. By default the number of Circuits enabled is 5.
- j) Press Enter to save the change and return into the main software menu.

Number of Expansion Boards (nEbd)

Select the number of expansion boards that are required using the steps outlined below.

- a) Use the up or down buttons to Navigate to the menu option **nEbd** and press enter.
- b) The current number of expansion boards configured is shown. Use the Up arrow to scroll to the required number of circuits. By default the number of expansion boards enabled is 0.
- c) Scroll to the desired expansion board number and press enter.
- d) Now select either IO or PARa to view/edit information specific to the board selected.

Real time clock (rtc)

This option allows the user to enter the current time and date for a Circuit controller when used in a standalone application. Note the rtc will automatically synchronize on a network system when connected to a Data Manager.

- a) Use the up or down buttons to scroll through the display until the display reads "rtc"
- b) Press enter. The display will show "t-1". Press enter again
- c) Scroll hours up or down (0 – 23) press enter
- d) Use up button to select "t-2", press enter
- e) Scroll minutes up or down (0 – 59) press enter
- f) Repeat for t-3 (seconds 0 – 59)
- g) Repeat for t-4 (Days up to 31)
- h) Repeat for t-5 (months up to 12)
- i) Repeat for t-6 (Year up to 99)
- j) Use up button to display "ESC", press enter to display "rtc"

Time clock is now set



Please ensure all power is switched off before installing or maintaining this product.

Network Configuration (nEt)

There are two network connection options for the main board.

- IP-L (Rotary switches set to "000")
- IP-r (Rotary switches set to "***")

IP-L allows the user to fix an IP address into the main board, which would be used when connecting the controller onto a customer's local area network. This would allow the customer to view each controller using Internet Explorer.

IP-r (normally used mode) allows the user to give each controller on the system a unique network ID. This ID is then allocated a dynamic IP address by the system DHCP server (such as the RDM Data Manager)

IP-L

To configure the Circuit Controller for IP-L, set all three rotary switches to zero. The unit should then be connected to the network.

1. nEt. From the function menu you can now select nEt
 - Press enter and the display will show "IP-L", press enter
 - You can now set the address using the table below
 -

Display	Option
IP-1	IP Address byte 1
IP-2	IP Address byte 2
IP-3	IP Address byte 3
IP-4	IP Address byte 4
nL	Network Mask Length
gt-1	Gateway Address byte 1
gt-2	Gateway Address byte 2
gt-3	Gateway Address byte 3
gt-4	Gateway Address byte 4
ESC	Exit network menu. N.B. this option must be selected to save any changes made in this menu

IP-r

To configure the Circuit Controller for IP-r, set the three rotary switches to a unique identifier (other than 000). The Circuit Controller should then be connected to the Data Manager IP network via the Ethernet port. The Data Manager will use DHCP to allocate the controller an IP address.

- From the function menu select nEt
- Press enter and the display will show "IP-r", press enter
- You can now view the address given by the DHCP server

IP1: Shows the first IP address value (10 in the example below)
 IP2: Shows the second IP address value (1 in the example below)
 IP3: Shows the third IP address value (2 in the example below)
 IP4: Shows the fourth IP address value (86 in the example below)

Example: 10.1.2.86



Please ensure all power is switched off before installing or maintaining this product.

Soft

To check on the current software version loaded on the controller, use the up or down buttons to Navigate to the menu option '**Soft**' and press enter. (USB stick should be formatted as FAT32)

USB Operation

The following operations can be performed using a memory-stick plugged into the USB port

- | | |
|-------------------------|------|
| 1. Export event log | U-01 |
| 2. Export logged data | U-02 |
| 3. Save configuration | U-03 |
| 4. Load configuration | U-04 |
| 5. Upgrade the software | U-05 |

The above requires the user to enter the USB menu via the display and press enter at the appropriate display.

Example; to save the current configuration, go to the USB menu, press enter, then the up key until U-03 is displayed. Press enter at this point, the screen will flash "USB" until the operation has completed. The file is transferred to the memory-stick in .zip format.

Touch Display Screens

The user can select what information is displayed on the Touch Display screen (PR0615) by using the up and down buttons to navigate to the menu option '**Scrn**' and press enter. This will bring up the options 0 (off) – 31

If IO is selected the first item will be displayed as I-01, which is Input 1. Pressing the Up or Down button will present the other IO items I-02, I-03 etc the outputs follow directly after the list of inputs and are shown as O-01, O-02. See the [Input/Output](#) Table to find what IO number corresponds to which actual input or output. Pressing the Enter button on the desired IO will show a snapshot of the current status of the IO, press enter for a second time to return to the list of IO and select another item to view.

Expansion Board Module ID

Up to 10 Expansion Boards can be connected to a single Circuit controller Main board. Each expansion board has a Module ID rotary switch which allows the user to assign a unique ID for each Expansion board in use.

During setup assign each expansion board a unique ID. Once assigned use the controller display to configure each [Expansion Board Setup](#). This operation can also be completed through the Circuit controller webpage interface.

When the rotary switch is set to 0 this equates to Expansion board 1.
When the rotary switch is set to 1 this equates to Expansion board 2 and so forth.
When the rotary switch is set to 9 this equates to Expansion board 10.

Parameter Table (d-01)

Shown below is a generic list of parameters. Each Circuit will have the same parameter list with the same parameter numbers. Under the dEty menu option to select **d-01** and then the circuit number (dSxx) you would like to view/edit parameters for.

If PARa is selected the first parameter option will be displayed as P-01. Pressing the Up or Down button will present the other parameter options P-02, P-03 etc. See [Parameter Table](#) to find what parameter number corresponds to which actual parameter.

Pressing the Enter button will show the current value of the selected parameter. Press Up or Down to modify the value, press Enter to save the value and return to the parameter software menu. The list of parameter numbers will be displayed again. Two other options are present in the parameter menu – dFLt and ESC. Selecting ESC will exit the parameter set-up mode. Selecting dFLt will reset all parameters back to the factory default values for the selected controller type, therefore use with caution.

For example P-01 for Circuit 1 would be "01 Temp Type", P-01 for Circuit 2 would be "02 Temp Type" etc.

P-02 for Circuit 1 would be "01 Valve type", P-02 for Circuit 2 would be "02 Valve Type" etc



Please ensure all power is switched off before installing or maintaining this product.

(d-01 – Ds-xx)

Number	Parameter	Range	Step	Units	Default
P-01	0xA Temp Type	0 = Avg. 1 = Min. 2 = Max	1		0
P-02	0xA Valve Type	0 = LLV. 1 = Step. 2 = Def Mon	1		0
P-03	0xA Cut In	-49.0 to 30.0 (-56.2 to 86.0)	0.1	°C (°F)	0.0 (32.0)
P-04	0xA OT Alarm	-60 to 128.0 (-76.0 to 262.4)	0.1	°C (°F)	5.0 (41.0)
P-05	0xA UT Alarm	-60 to 128.0 (-76.0 to 262.4)	0.1	°C (°F)	-2.0 (28.4)
P-06	0xA Alarm Delay	00:00 to 99:00	01:00	mm:ss	20:00
P-07	0xA Diff	-60 to 128.0 (-76.0 to 262.4)	0.1	°C (°F)	1.5 (2.7)
P-08	0xA Cut In Offset	-60 to 128.0 (-76.0 to 262.4)	0.1	°C (°F)	5.0 (9.0)
P-09	0xA Response On	1 to 60	1		10
P-10	0xA Response Off	1 to 60	1		10
P-20	0xA Defrost Mode	0=Local. 1=Remote	1		0
P-21	0xA Defrost Start	00:00 – 23:59	00:01	hh:mm	01:00
P-22	0xA Defrost Number	0 - 12	1		6
P-23	0xA No Defrost Time	0 - 180	1		12
P-24	0xA Defrost Termination	-60 to 128.0 (-76.0 to 262.4)	0.1	°C (°F)	10.0 (50.0)
P-25	0xA Defrost Min	00:00 to 99:00	01:00	mm:ss	05:00
P-26	0xA Defrost Max	00:00 to 99:00	01:00	mm:ss	24:00
P-27	0xA Drain Down	00:00 to 99:00	01:00	mm:ss	05:00
P-28	0xA Recovery	00:00 to 99:00	01:00	mm:ss	30:00
P-29	0xA Pump Down	00:00 to 60:00	01:00	mm:ss	00:45
P-30	0xA Defrost Skip	0 = Off. 1 = On	1		1
P-31	0xA Defrost Skip Time	00:00 to 99:00	01:00	mm:ss	12:00
P-40	0xA Fan Delay	00:00 to 99:00	01:00	mm:ss	00:00
P-41	0xA Fan In Defrost	0 = Off. 1 = On	1		1
P-42	0xA Trim In Defrost	0 = Off. 1 = On	1		0
P-43	0xA Trim Level	0 to 100	1	%	100
P-44	0xA Trim Low	0 to 100	1	%	30
P-45	0xA Trim High	0 to 100	1	%	100
P-50	0xA Humidity Sensor	0 to 83	1		0
P-51	0xA Humidity Low	0 to 100		rH	20
P-52	0xA Humidity High	0 to 100		rH	60
P-53	0xA Press Sensor	0 to 83	1		0
P-54	0xA Press Span *	-3.4 to 50 (-49.0 to 725.0)	0.1	Bar (Psi)	13.8 (200.1)
P-55	0xA Press Offset *	-3.4 to 50 (-49.0 to 725.0)	0.1	Bar (Psi)	0.0
P-60	0xA Lights Mode	0=Local. 1=Remote	1		0
P-61	0xA Sun Lights On	00:00 to 23:59	00:01	hh:mm	08:00
P-62	0xA Sun Lights Off	00:00 to 23:59	00:01	hh:mm	20:00
P-63	0xA Mon Lights On	00:00 to 23:59	00:01	hh:mm	08:00
P-64	0xA Mon Lights Off	00:00 to 23:59	00:01	hh:mm	20:00
P-65	0xA Tue Lights On	00:00 to 23:59	00:01	hh:mm	08:00
P-66	0xA Tue Lights Off	00:00 to 23:59	00:01	hh:mm	20:00
P-67	0xA Wed Lights On	00:00 to 23:59	00:01	hh:mm	08:00
P-68	0xA Wed Lights Off	00:00 to 23:59	00:01	hh:mm	20:00
P-69	0xA Thu Lights On	00:00 to 23:59	00:01	hh:mm	08:00
P-70	0xA Thu Lights Off	00:00 to 23:59	00:01	hh:mm	20:00
P-71	0xA Fri Lights On	00:00 to 23:59	00:01	hh:mm	08:00
P-72	0xA Fri Lights Off	00:00 to 23:59	00:01	hh:mm	20:00
P-73	0xA Sat Lights On	00:00 to 23:59	00:01	hh:mm	08:00
P-74	0xA Sat Lights Off	00:00 to 23:59	00:01	hh:mm	20:00
P-47	0xA Door stops LLV	0 = No. 1 = Yes	1		0
P-48	0xA Door stops Fan	0 = No. 1 = Yes	1		0
P-49	0xA Man stops LLV/Fan	0 = No. 1 = Yes	1		0
P-50	0xA Prb48 Device	0 to 99	1		0



Please ensure all power is switched off before installing or maintaining this product.

Number	Parameter	Range	Step	Units	Default
P-52 ↓ P-63	0xB C1 Case Probe ↓ 0xM C12 Case Probe	0 to 88	1		0
P-64 ↓ P-75	0xB C1 Defrost Probe ↓ 0xM C12 Defrost Probe	0 to 88	1		0
P-76 ↓ P-87	0xB C1 Monitor Probe ↓ 0xM C12 Monitor Probe				
P-88	0xA Case Clean	0 to 92	1		0
P-89	0xA Man Def	0 to 92	1		0
P-90	0xA Term Def	0 to 92	1		0
P-91	0xA Door SW	0 to 92	1		0
P-92	0xA Man Trap	0 to 92	1		0
P-93	0xA Temp SW	0 to 92	1		0
P-94	0xA LLV Relay	0 to 132	1		0
P-95	0xA Defrost Relay	0 to 132	1		0
P-96	0xA Fan Relay	0 to 132	1		0
P-97	0xA Trim Relay	0 to 132	1		0
P-98	0xA Lights Relay	0 to 132	1		0
P-99	0xA Hot Gas Relay	0 to 132	1		0
P-100	0xA Remote Relay	0 to 132	1		0
P-101	0xA Stepper	0 to 60	1		0
P-102	0xA Door Alarm Delay	00:00 to 99:00	01:00	mm:ss	
P-103	Number of Probes	0 to 12	12		
DFLt	Restore default values				

* Span and Offset allows for the full range of the transducer to be used by the controller.

Span is the full range of the transducer

Offset is the value below zero.

Note. The controller uses absolute pressure; if gauge pressure is required, add +1 Bar to the offset value.

Example: RDM PR0160 Transducer with range: -1 bar to 20 bar (-14.5 to 290 psi)
Span would be (21 bar)
Offset would be (-1 bar)



Please ensure all power is switched off before installing or maintaining this product.

Parameter Description (d-01)

Number	Parameter	Description
P-01	0Xa Temp Type	Selects how Control Temperature is calculated: - Avg or Min or Max. See Temp Type
P-02	0Xa Valve Type	Selects Valve Type: - LLV or Stepper or Def Mon See Valve Type
P-03	0Xa Cut In	Temperature at which the LLV or Stepper will switch on.
P-04	0Xa OT Alarm	Over temperature alarm set point. See OT / UT Alarms
P-05	0Xa UT Alarm	Under temperature alarm set point. See OT / UT Alarms
P-06	0Xa Alarm Delay	Delay before an over or under-temperature alarm is generated.
P-07	0Xa Diff	Differential temperature below the cut-in temperature. The LLV or Stepper switches off when below this temperature
P-08	0Xa Cut In Offset	Offset to Cut-In to give Second Set Point See Cut-In Offset
P-09	0Xa Response On	Allows the user to speed up/slow down the stepper output On speed (Option: - 1 to 60 with 60 being fastest response)
P-10	0Xa Response Off	Allows the user to speed up/slow down the stepper output Off speed (Option: - 1 to 60 with 60 being fastest response)
P-20	0Xa Defrost Mode	Allows the user to set the defrost mode: - <ul style="list-style-type: none"> ➤ Local (Uses the internal parameters P-12 and P-13) ➤ Remote (Requires a defrost schedule in the Data Manager)
P-21	0Xa Defrost Start	When defrost mode is set to "Local" at P-11, this is the start time for the first defrost
P-22	0Xa Defrost Number	When defrost mode is set to "Local" at P-11, this is the number of defrosts per day equally spaced from the start time.
P-23	0Xa No Defrost Time	If the controller misses a defrost command for any reason. A defrost will initiate after this time has elapsed from the last defrost. Note this parameter is active even if no defrosts configured.
P-24	0Xa Defrost Termination	The defrost will terminate when the Defrost Temperature reaches this value. See Defrost Temp
P-25	0Xa Defrost Min	Minimum time that a defrost will use (Defrost can't terminate until this time has elapsed. If termination temperature is reached during this period, the defrost control relay is turned off, but the controller will not continue the defrost cycle until the end of the defrost min period) See also Def Max.
P-26	0Xa Defrost Max	Time period after defrost minimum that defrosts are allowed to terminate. Note : Defrost Min time is included in the Defrost Max time. i.e. If Def Min set to 10 minutes and Def Max set to 40 minutes, then the defrost will last at least 10 minutes but no more than 40 minutes
P-27	0Xa Drain Down	A period after defrost max to allow the draining of any surplus water
P-28	0Xa Recovery	The LLV is switched on at the start of this period to allow the temperature to recover to the normal operating setpoint. This period also inhibits the OT alarm. The controller will exit Recovery when all control probes fall below the OT setpoint or the Recovery time delay expires. Note that if any one control temperature probe is still above the OT alarm setpoint when this period expires, an immediate OT alarm occurs; there is not a further alarm delay.
P-30	0Xa Defrost Skip	Allows user to enable/disable defrost skip. This feature allows the controller to skip defrosts. If the current defrost terminates on temperature then the controller will skip the next scheduled defrost providing the previous defrost terminated before the defrost skip time (P-31).
P-31	0xa Defrost Skip Time	Time factor used in defrost skip. The previous defrost has to terminate before this value expires to allow the controller to skip a defrost.
P-40	0Xa Fan Delay	Time after a drain-down period before the fans start
P-41	0Xa Fan In Defrost	Allows the user to set the fans on or off in defrost. Note if the fans are set to on in defrost, they will go off for the drain-down period and then follow P-20



Please ensure all power is switched off before installing or maintaining this product.

Number	Parameter	Description
P-42	0Xa Trim In Defrost	Allows the trims to be off or on during a defrost
P-43	0Xa Trim Level	<p>Sets a percentage level, of a 5-minute period, to pulse the trim heater relay off/on.</p> <p>Example: - P-23 set to 50% = 2.5 minutes on, 2.5 minutes off. The controller will use the Trim Level parameter if there is no Humi Sensor fitted or a sensor failure occurs.</p> <p>If a humidity sensor is in use then the controller will pulse the trim output based on site Rh conditions and will ignore P-23. See Trim Operation</p> <p>If the controller is networked to a Data Manager operating the energy feature Trim Control then the Data Manager feature will override P-23. Please refer to the Data Manager user document for further details.</p> <p>Note the trims are turned off when an over temperature alarm occurs</p>
P-44	0Xa Trim Low	Sets trim low level. See Trim Operation
P-45	0Xa Trim High	Sets trim high level. See Trim Operation
P-50	0Xa Humidity Sensor	Selects which Analogue Input is being used to measure Humidity*
P-51	0Xa Humidity Low	Sets humidity low level. See : Trim Operation
P-52	0Xa Humidity High	Sets humidity high level. See : Trim Operation
P-53	0Xa Press Sensor	Selects which Analogue Input is being used to measure Pressure. This provides a monitoring function only with no alarm capability.
P-54	0Xa Press Span	Range of the transducer
P-55	0Xa Press Offset	Transducer value below zero
P-60	0Xa Lights Mode	<p>Allows the user to set the lights mode: -</p> <ul style="list-style-type: none"> ➤ Always off ➤ Always on ➤ Use a local schedule P-33 to P-46) ➤ Use a remote schedule (Set up in the system front end)
P-61	0Xa Sun Lights On	When P-32 is set to Local, Sunday on time
P-62	0Xa Sun Lights Off	When P-32 is set to Local, Sunday off time
P-63	0Xa Mon Lights On	When P-32 is set to Local, Monday on time
P-64	0Xa Mon Lights Off	When P-32 is set to Local, Monday off time
P-65	0Xa Tue Lights On	When P-32 is set to Local, Tuesday on time
P-66	0Xa Tue Lights Off	When P-32 is set to Local, Tuesday off time
P-67	0Xa Wed Lights On	When P-32 is set to Local, Wednesday on time
P-68	0Xa Wed Lights Off	When P-32 is set to Local, Wednesday off time
P-69	0Xa Thu Lights On	When P-32 is set to Local, Thursday on time
P-70	0Xa Thu Lights Off	When P-32 is set to Local, Thursday off time
P-71	0Xa Fri Lights On	When P-32 is set to Local, Friday on time
P-72	0Xa Fri Lights Off	When P-32 is set to Local, Friday off time
P-73	0Xa Sat Lights On	When P-32 is set to Local, Saturday on time
P-74	0Xa Sat Lights Off	When P-32 is set to Local, Saturday off time
P-75	0Xa Door stops LLV	This parameter is used to close the LLV if the door opens
P-76	0Xa Door stops Fan	This parameter is used to stop the Fans if the door opens
P-77	0Xa Man stops LLV/Fan	When man trap input is activated the LLV closes and Fans are stopped. Normal operation resumes when the mantrap input is
P-78	0Xa Prb48 Brd	Selects the position of 48 Probe Expansion Board (Set on Rotary switch)
P-80	Number of probes	Hides and disables the probes that are unused (temperature, defrost
P-81	0Xb C1 Case Probe	Selects Circuit 1 Case 1 Control Probe*
↓	↓	
P-92	0Xm C112 Case Probe	



Please ensure all power is switched off before installing or maintaining this product.

Number	Parameter	Description
P-101 ↓ P-112	0Xb C1 Defrost Probe ↓ 0Xm C12 Defrost Probe	Selects Circuit 1 Case 1 Defrost Probe*
P121 ↓ P-132	0Xb C1 Monitor Probe ↓ 0Xm C12 Monitor Probe	Selects Circuit 1 Case 1 Monitor Probe*
P-140	0Xa Case Clean	Selects Status Input for Circuit 1 Case Clean. When this input is active the Circuit is placed into Case Off until the input is removed.
P-141	0Xa Man Def	Selects Status Input for Circuit 1 Manually Forced Defrost. When this input is active the Circuit starts a Defrost. Note if the input remains active the controller will only complete 1 defrost cycle before
P-142	0Xa Term Def	Selects Status Input for Circuit 1 Manually Terminated Defrost. When this input is active the controller will terminate it's defrost even if the Termination temperature has not been reached. Note the input will only operate in Defrost Max state. If activated whilst in the Defrost
P-143	0Xa Door SW	Selects Status Input for Circuit 1 Door Sensor Switch. When this input is active it signals to the controller that the Door is open for a Coldroom application. A Plant Fault alarm will then be generated. See
P-144	0Xa Man Trap	Selects Status Input for Circuit 1 Man Trap Switch. When this input is active the controller generates a Mantrap alarm. See also P-49.
P-145	0Xa Temp SW	Selects Status Input for Circuit 1 Cut-In Offset. When this input is active the offset defined in P-05 is added to the current operating
P-146	0XA Plt SW	Used tp map Circuit 1 Plant Switch
P-150	0Xa LLV Relay	Used to map Circuit 1 LLV Relay*
P-151	0Xa Defrost Relay	Used to map Circuit 1 Defrost Relay*
P-152	0Xa Fan Relay	Used to map Circuit 1 Fan Relay*
P-153	0Xa Trim Relay	Used to map Circuit 1 Trim Heater Relay*
P-154	0Xa Lights Relay	Used to map Circuit 1 Lights Relay*
P-155	0Xa Hot Gas Relay	Used to map Circuit 1 Hot Gas Relay*
P-156	0Xa Remote Relay	Used to map Circuit 1 Remote Relay*
P-157	0Xa Stepper	Used to map Circuit 1 Stepper Valve Output*
P-158	0Xa Door Alarm Delay	Delay after the door open input is activated before the alarm occurs.
dFLt	Restore default values	Restores all of the parameters to their default values*

* See [Input and Output Allocations](#)



Please ensure all power is switched off before installing or maintaining this product.

Parameter Table (d-02)

Shown below is the list of parameters for the hardware menu. Under the dEty menu option select **d-02** and then dS01. Use the arrows to select Para

The first parameter option will be displayed as P-01. Pressing the Up or Down button will present the other parameter options P-02, P-03 etc. See [Parameter Table](#) to find what parameter number corresponds to which actual parameter.

(d-02 – Ds-01)

Number	Parameter	Range	Step	Units	Default
P-01	M01 Uni 1	0= 4-20mA-I , 1= 0-10v-I , 2= 0-5v-I , 3= 0.5-4.5-I , 4= 0.5-9.5v-I , 5= 1-2v-I , 6= 1-6v-I , 7= 4-20Ma-O , 8= 0-20mA-O , 9= 0-10v-O , 10= 0-5v-O , 11= 1-5v-O .	1		1
P-02	M01 Uni 2		1		1
P-03	M01 Uni 3		1		1
P-04	M01 Uni 4		1		1
P-05	M01 Uni 5		1		1
P-06	M01 Uni 6		1		1
P-07	M01 Uni 7		1		1
P-08	M01 Uni 8		1		1
P-10	M01 Status Inp	0=0v, 1=24Vac	1		0
P-20	M01 Inv Rly 1	0=Off, 1=On	1		0
P-21	M01 Inv Rly 2	0=Off, 1=On	1		0
P-22	M01 Inv Rly 3	0=Off, 1=On	1		0
P-23	M01 Inv Rly 4	0=Off, 1=On	1		0
P-24	M01 Inv Rly 5	0=Off, 1=On	1		0
P-25	M01 Inv Rly 6	0=Off, 1=On	1		0
P-26	M01 Inv Rly 7	0=Off, 1=On	1		0
P-27	M01 Inv Rly 8	0=Off, 1=On	1		0
P-28	M01 Inv Rly 9	0=Off, 1=On	1		0
P-29	M01 Inv Rly 10	0=Off, 1=On	1		0
P-30	M01 Inv Rly 11	0=Off, 1=On	1		0
P-31	M01 Inv Rly 12	0=Off, 1=On	1		0
P-40	M01 Offset 1	-20 - 20 (-4 - 68)	0.1	°C (°F)	0.0
P-41	M01 Offset 2	-20 - 20 (-4 - 68)	0.1	°C (°F)	0.0
P-42	M01 Offset 3	-20 - 20 (-4 - 68)	0.1	°C (°F)	0.0
P-43	M01 Offset 4	-20 - 20 (-4 - 68)	0.1	°C (°F)	0.0
P-44	M01 Offset 5	-20 - 20 (-4 - 68)	0.1	°C (°F)	0.0
P-45	M01 Offset 6	-20 - 20 (-4 - 68)	0.1	°C (°F)	0.0
P-46	M01 Offset 7	-20 - 20 (-4 - 68)	0.1	°C (°F)	0.0
P-47	M01 Offset 8	-20 - 20 (-4 - 68)	0.1	°C (°F)	0.0
P-50	M01 Step Reset	0 - 25	6		6
P-60	M01 Step Type 1	0= Carel , 1= Sporlan1 , 2= Sporlan2 , 3= Alco , 4= Other	1		1
P-61	M01 Step Type 2		1		1
P-70	M01 Step Max 1	0 - 6400	1		2500
P-71	M01 Step Max 2	0 - 6400	1		2500
P-80	M01 Step Close 1	0 - 6400	1		3500
P-81	M01 Step Close 2	0 - 6400	1		3500
P-90	M01 Step Speed 1	0 - 6400	1		200
P-91	M01 Step Speed 2	0 - 6400	1		200
P-100	M01 Step mA Peak 1	0 - 825	1		80
P-101	M01 Step mA Peak 2	0 - 825	1		80
P-110	M01 Step Half 1	0=Off, 1=On	1		0
P-111	M01 Step Half 2	0=Off, 1=On	1		0
P-120	M01 Step mA Hold 1	0 - 825	1	mA	0
P-121	M01 Step mA Hold 2	0 - 825	1	mA	0



Please ensure all power is switched off before installing or maintaining this product.

Parameter Description (d-02)

Number	Parameter	Description
P-01 ↓ P-08	M01 Uni 1 ↓ M01 Uni 8	Select the type of universal input or output, such as 4-20mA in or 0-10vdc out.
P-10	M01 Status Inp	Select whether 0V return or 24V ac
P-20 ↓ P-31	M01 Inv Rly 1 ↓ M01 Inv Rly 12	Used to invert relay operation
P-40 ↓ P-47	M01 Offset 1 ↓ M01 Offset 8	Offset probe readings by this amount, this allows calibration due to resistance drop over long cable lengths.
P-50	M01 Step Reset	After a set amount of stepper valve operation hours (default 6) the valve will automatically close fully to recalibrate it's position.
P-60	M01 Step Type 1	Selects the type of stepper valve to be driven.
P-61	M01 Step Type 1	Selects the type of stepper valve to be driven
P-70	M01 Step Max 1	The number of steps to open the valve fully if valve type is set to "other"
P-71	M01 Step Max 2	The number of steps to open the valve fully if valve type is set to "other"
P-80	M01 Step Close 1	The number of steps to close the valve fully if valve type is set to "other", this is normally higher than the maximum open steps to ensure the valve is fully shut.
P-81	M01 Step Close 2	The number of steps to close the valve fully if valve type is set to "other", this is normally higher than the maximum open steps to ensure the valve is fully shut.
P-90	M01 Step Speed 1	The step speed in Hz if the valve type is set to "other"
P-91	M01 Step Speed 2	The step speed in Hz if the valve type is set to "other"
P-100	M01 Step mA Peak 1	The maximum current that can be delivered to the valve if the valve type is set to "other"
P-101	M01 Step mA Peak 2	The maximum current that can be delivered to the valve if the valve type is set to "other"
P-110	M01 Step Half 1	Allows the valve to be opened or closed in half step increments if valve type is set to "other"
P-110	M01 Step Half 2	Allows the valve to be opened or closed in half step increments if valve type is set to "other"
P-120	M01 Step mA Hold 1	The holding current that will be applied to the valve to stop it drifting if valve type is set to "other"
P-121	M01 Step mA Hold 2	The holding current that will be applied to the valve to stop it drifting if valve type is set to "other"



Please ensure all power is switched off before installing or maintaining this product.

Parameter Table (d-03)

Shown below is the parameter to set the expansion board type. Under the dEty menu option select **d-03** and then dS0xx (1-10). Use the arrows to select Para

The first parameter option will be displayed as P-01. Pressing the Up or Down button will present the other parameter options P-02, P-03 etc. See [Parameter Table](#) to find what parameter number corresponds to which actual parameter.

(d-03 – Ds-xx)

Number	Parameter	Range	Step	Units	Default
P-01	Board Type	0=Unused, 1=IO, 2=Stepper, 3= Probe48	1		0

Parameter Description (d-03)

Number	Parameter	Description
P-01	Board Type	Selects the type of expansion board being used, IO board, Stepper or 48 Probe.

Parameter Table (d-04)

Shown below is the parameter list for the controller setup. Under the dEty menu option select **d-04** and then dS01 . Use the arrows to select Para

The first parameter option will be displayed as P-01. Pressing the Up or Down button will present the other parameter options P-02, P-03 etc. See [Parameter Table](#) to find what parameter number corresponds to which actual parameter.

Number	Parameter	Range	Step	Units	Default
P-01	S01 Circuits	0 - 25	1		5
P-02	S01 Probe Type	0 -22 (See Probe Types)	1		22
P-03	S01 Press Type	0=bar, 1=psi	1		2
P-04	S01 Ext Devices	0 - 10	1		10
P-05	S01 Screen Dev	0 - 37	1		0
P-06	S01 Select Tabs	0=Off, 1=Web Interace, 2=Touch, 3=Web/Touch	1		1

Parameter Description (d-04)

Number	Parameter	Description
P-01	S01 Circuits	Selects the number of circuits that are required
P-02	S01 Probe Type	Sets the probe type being used
P-03	S01 Press Type	Sets the pressure type required
P-04	S01 Ext Devices	Sets the amount of expansion boards being used (1-10)
P-05	S01 Screen Dev	Sets what information is displayed on the Plant Touch Screen
P-06	S01 Select Tabs	Sets where the Tabs are displayed



Please ensure all power is switched off before installing or maintaining this product.

Input and Output Allocations

The following information can be used to assist with the setup of the circuit controller. For each circuit configured input and outputs must be mapped from the main board or an expansion board or a 48 channel monitor. The tables below list the software values that a Circuit uses when mapping inputs and outputs. The tables quickly allow the end user to determine an input or an output number for a given expansion board module ID and type.

Main Controller Board

Probe Input Numbers (1-8)	Universal IO Numbers (1-8)	Status Input Numbers (1-12)	Relay Numbers (1-12)	Stepper Outputs (1-2) PR0652 Only
1 to 8	1 to 8	1 to 12	1 to 12	1-10*

*Positions 3-10 are not currently used

IO Expansion Board PR0661

Rotary Switch Position	Probe Input Numbers (1-8)	Universal I/O Numbers (1-8)	Status Input Numbers (1-8)	Relay Numbers (1-12)
0 (Board 1)	9 to 16	9 to 16	13 to 20	13 to 24
1 (Board 2)	17 to 24	17 to 24	21 to 28	25 to 36
2 (Board 3)	25 to 32	25 to 32	29 to 36	37 to 48
3 (Board 4)	33 to 40	33 to 40	37 to 44	49 to 60
4 (Board 5)	41 to 48	41 to 48	45 to 52	61 to 72
5 (Board 6)	49 to 56	49 to 56	53 to 60	73 to 84
6 (Board 7)	57 to 64	57 to 64	61 to 68	85 to 96
7 (Board 8)	65 to 72	65 to 72	69 to 76	97 to 108
8 (Board 9)	73 to 80	73 to 80	77 to 84	109 to 120
9 (Board 10)	81 to 88	81 to 88	85 to 92	121 to 132

Stepper Expansion Board PR0660

Rotary Switch Position	Probe Inputs Numbers (1-8)	Universal I/O Numbers (1-8)	Status Inputs Numbers (1-8)	Relay Numbers (1-4)	Stepper Outputs (1-6)
0 (Board 1)	9 to 16	9 to 16	13 to 20	13 to 16	11-16
1 (Board 2)	17 to 24	17 to 24	21 to 28	25 to 28	17-22
2 (Board 3)	25 to 32	25 to 32	29 to 36	37 to 40	23-28
3 (Board 4)	33 to 40	33 to 40	37 to 44	49 to 52	29-34
4 (Board 5)	41 to 48	41 to 48	45 to 52	61 to 63	35-40
5 (Board 6)	49 to 56	49 to 56	53 to 60	73 to 76	41-46
6 (Board 7)	57 to 64	57 to 64	61 to 68	85 to 88	47-52
7 (Board 8)	65 to 72	65 to 72	69 to 76	97 to 100	53-58
8 (Board 9)	73 to 80	73 to 80	77 to 84	109 to 112	59- 64
9 (Board 10)	81 to 88	81 to 88	85 to 92	121 to 124	65-70

48 Probe Expansion Board 662

Rotary Switch Position	Probe/Status Input Numbers	Universal I/O Numbers
0 (Board 1)	1 to 48	9 to 16
1 (Board 2)	1 to 48	17 to 24
2 (Board 3)	1 to 48	25 to 32
3 (Board 4)	1 to 48	33 to 40
4 (Board 5)	1 to 48	41 to 48
5 (Board 6)	1 to 48	49 to 56
6 (Board 7)	1 to 48	57 to 64
7 (Board 8)	1 to 48	65 to 72
8 (Board 9)	1 to 48	73 to 80
9 (Board 10)	1 to 48	81 to 88



Please ensure all power is switched off before installing or maintaining this product.

See also 48 Input Expansion Board Additional Setup

Expansion Board - Communication Loss

If the Main controller loses communication to any Expansion board, for a period of time greater than five minutes, then an alarm "X Board Offline" will be created. Where X relates to the specific board number which has lost communication. There is no local control within the Expansion boards, therefore should an Expansion board lose communication to the Main board the Expansion board outputs will remain in the last known state until communications are returned. If an Expansion board is powered on without the CANBUS network connection to the Main controller then all the outputs from the Expansion board will be off e.g. Relays are de-energised etc.

48 Input Expansion Board

Once the Module ID has been assigned and the board type selected for a given 48 Input Expansion board the following process has to be completed.

Parameter 50 "0x Prb48 Device" (x being Circuit Number)

The above parameter has to be set to match the Expansion Board Module ID. For example if the rotary switch is set to 3 on a given 48 Input Expansion board then Parameter 50 in the associated Circuit parameters needs to be 3.

Temperature Type

Parameter (P-01) calculates the value used for the Control Temperature.

Set to 0 = Avg : Controller uses the average of all probes selected to control to set point (P-03)

Set to 1 = Min : Controller uses the probe with the lowest temperature reading to control to set point (P-03)

Set to 2 = Max : Controller uses the probe with the highest temperature reading to control to set point (P-03)

Parameters (P-52 to P-63) "Case Prb" selects which probe inputs are assigned to a circuit and therefore used to generate the Control Temp.

For probe numbers see [Input Output Allocations](#)

Valve Type

Parameter (P-02) sets valve type which is being used in refrigeration control strategy.

Set to 0 = LLV

Set to 1 = Step

Set to 2 = Mon

Liquid Line Solenoid Valve is being used to control refrigerant flow.

Stepper Motor Valve (EEPR) is being used to control refrigerant flow

Mechanical valve (EPR) is being used to control refrigerant flow. Note that the LLV will be on refrigeration, but will close during the defrost states (Df Min, Df Max, Drain down and Fan delay).

Parameter (P-94) allows the user to assign which relay output the LLV is connected to for a given circuit.

Parameter (P-101) allows the user to assign which Stepper Output the Stepper Motor is connected to for a given circuit.

For output numbers see [Input Output Allocations](#)



Please ensure all power is switched off before installing or maintaining this product.

Stepper Valve Type

Parameters P-70, P71, P80, P-81, P-90, P-91, P100, P101, P-110 & P-111 only have an effect if "Other" is selected when configuring parameter P-30. Other allows the user to map in the requirements the stepper valve.

Selecting option 0, 1, 2 or 3 at parameter P-60/P-61 sets the controller for use with the factory set values for the type of valve selected. The controller will override any values set in parameters P-70 – P-111.

Note the parameters relating to the Stepper Valve type should be configured prior to wiring the Stepper Valve to the Circuit controller. If one of the three default valve types is selected then changing P-70 – P-111 will have no effect.

Manufacturer	Model	Step Max	Step Close	Step Speed (Hz)*	mA Peak	mA Hold	Half Step	Overdrive (Hours)
Carel	E ³ V	480	500	50	450	0	Off	8
Sporlan 1	SER A/B/C/D	2500	3500	200	80	0	Off	24
Sporlan 2	SER 1.5 to 20 / SEI 6	1596	1756	200	80	0	Off	24
Alco	EX4/5/6	750	825	500	500	0	Off	8
Other	Various	2500	3500	200	80	0	Off	24

Valve Wiring

Manufacturer	Model	Wiring (Colours)	Connection Description (See Stepper Output)
Carel	E ³ V	Yellow	M1B
		White	M1A
		Green	M2A
		Brown	M2B
Sporlan	SER 1.5 - 20 SER B/C/D SEI 6	Green	M1B
		Red	M1A
		White	M2A
		Black	M2B
Alco	EX4/EX5/EX6	White (A)	M1B
		Black (B)	M1A
		Blue (C)	M2A
		Brown (D)	M2B

Important – Our information is taken from 3rd party data sheets at the time our document is created, any changes since will not be incorporated in our document.

Review the manufacturer's datasheet for the selected valve before installation. If you are unsure regarding any of the above steps please contact RDM Technical Support for further assistance.

Valve State – Overdriving

Each time the controller is powered on the control valve state has to initialise as the controller will have no knowledge of the current valve opening position for the stepper motor attached. During this process the controller will close the valve by a number of steps greater than the total number of steps for the valve configured. This is achieved using the Step Close parameter and is referred to as "overdriving" the valve. This process will synchronize the controller with the stepper valve output. This ensures the stepper valve is at the 0 steps position, fully closed and the control algorithm will use this for future control operations.

The overdrive parameter (P-50) will overdrive the Stepper motor output by 10% of the step max value at the preset period (24 hours for example), this automatically re synchronises the valve.

Please consult the stepper valve manufacturer's data sheet to obtain the number of steps required to overdrive the valve.



Please ensure all power is switched off before installing or maintaining this product.

Cut-In Offset

Parameter (P-08) allows for an offset to be added to the cut-in temp set point. This offset is added to the cut-in temp when status input (P-93) "Temp Sw" is activated.
Note this offset is also added to the Over and Under temperature alarm set points.

For example if the Cut In set point is 0, the OT alarm is 5 and UT alarm is -2 then a Cut-In offset of +4 is added then the new Cut-In set point would be +4, new OT alarm would be 9 and UT alarm +2

For status input numbers see [Input Output Allocations](#)

OT UT Alarms

Over and Under temperature alarms occur when any of the Case Probes selected for control purposes in a given Circuit, P-52 to P-63, rise above or drop below the over or under temperature alarm set point and the alarm delay period has expired.

Once an alarm has been generated the user must view the Circuit for which the alarm has been created and determine the source of the alarm. Note OT alarms will always override UT alarms.

Defrost Termination

Defrost termination depends on setting of parameter (P-01) Temperature Type

- Set to 0 = Avg Defrost will terminate when the average of all probes selected reaches the termination temperature
- Set to 1 = Min Defrost will terminate when the probe with the lowest temperature reaches the termination temperature. i.e. All defrost probes will have reached the termination temperature.
- Set to 2 = Max Defrost will terminate when the probe with the highest temperature reaches the termination temperature. i.e. Defrost will terminate when the first of the probes selected reaches the termination temperature.

Parameters (P-64 to P-75) "Def Prb" Selects which probes are enabled as Defrost Probes.

For probe numbers see [Input Output Allocations](#)

[See also Appendix 2 Defrost Cycles](#)

Relay and display states during defrost

State:	Pump Down (fixed 45 seconds)	Defrost Min	Defrost Max	Drain Down	Fan Delay	Recovery
Display	dEF	dEF	dEF	dEF	dEF	rEC
LLV / Stepper Valve	Closed/Closes	Closed	Closed	Closed	Open	Open
Defrost Relay	Off	On	On	Off	Off	Off
Fan Relay (On in def)	On	On	On	On	Off	On
Fan Relay (Off in def)	Off	Off	Off	Off	Off	On
Trim Relay (On in def)	On	On	On	On	On	On
Trim Relay (Off in def)	Off	Off	Off	Off	Off	On
Lights relay	As per Schedule	As per Schedule	As per Schedule	As per Schedule	As per Schedule	As per Schedule



Please ensure all power is switched off before installing or maintaining this product.

Trim Operation

The circuit controller will switch an associated Circuits Trim Relay in accordance with the setup parameters below.

Humi Sensor	1		Trim Level	100%
Humidity Low	20rH		Humidity High	60rH
Trim Low	30%		Trim High	100%

Humi Sensor Use this to select the source of the humidity reading. The humidity sensor in the above example is mapped to Universal Input 1 on the main board.

Humidity Low When the rH level for the Humi Sensor is below Humidity Low the Trim Relay will pulse to a duration set by the "Trim Low" parameter.

Humidity High When the rH level for the Humi Sensor is above Humidity High the Trim Relay will pulse to a duration set by the Trim High parameter.

When the rH level is above Humidity Low, but below Humidity High, then the Trim Relay will pulse in proportion to the line drawn between the Low and High levels. As shown in the figure below.

If no Input is selected for parameter Humi Sensor, i.e. Humi Sensor = 0, then the Trim Relay will be fixed and pulse at whatever value is set in parameter "Trim Level".

The Trim Relay pulses over a period of 5 minutes. For example if the humidity reading is 20rH then Trim Relay will pulse on and off at of period 30% On and 70% Off (30% of 5 minutes = 90 seconds On and 70% of 5 minutes = 210 seconds off).

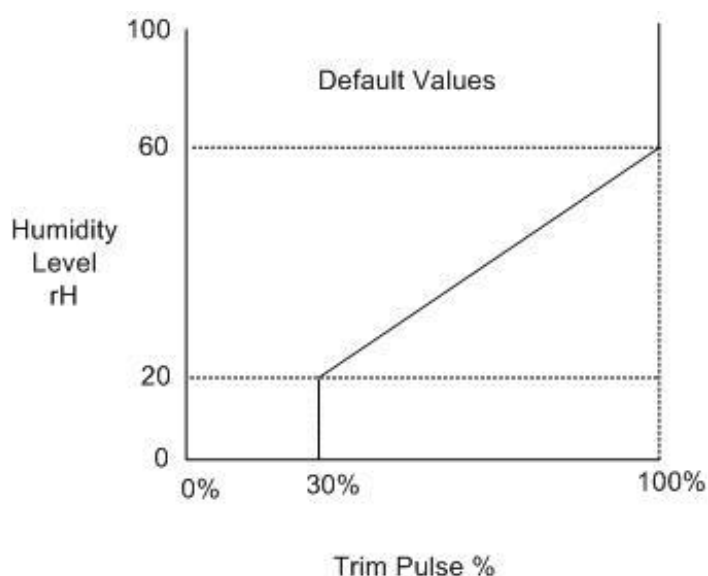

If the Data Manger Energy feature is enabled and is directed to the Circuit controller then the Data Manager calculated trim percentage will override any local settings.

See RDM Data Manager Commissioning Guide for further details.



Please ensure all power is switched off before installing or maintaining this product.

Expansion Board Wiring Connections

Intuitive Stepper Expansion Board Wiring Connections

PR0660
Bottom Row

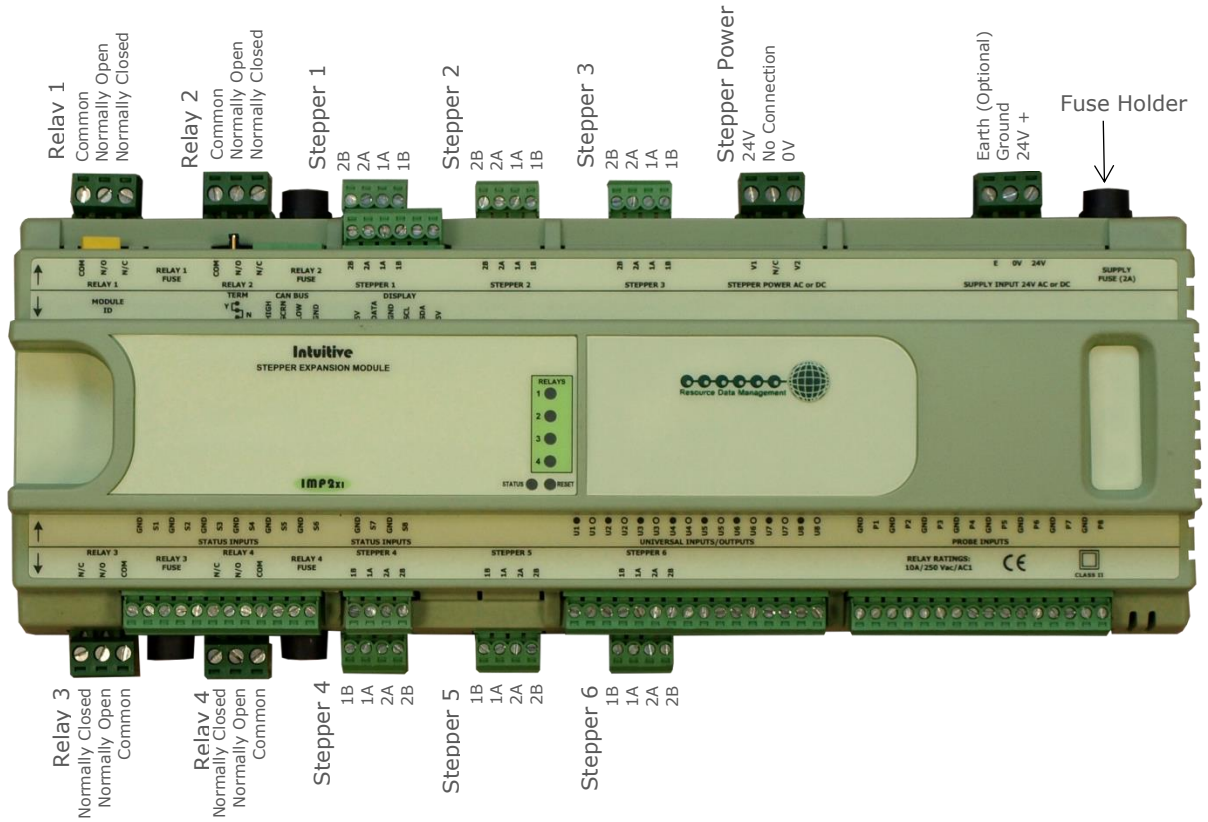

PR0660
Top Row

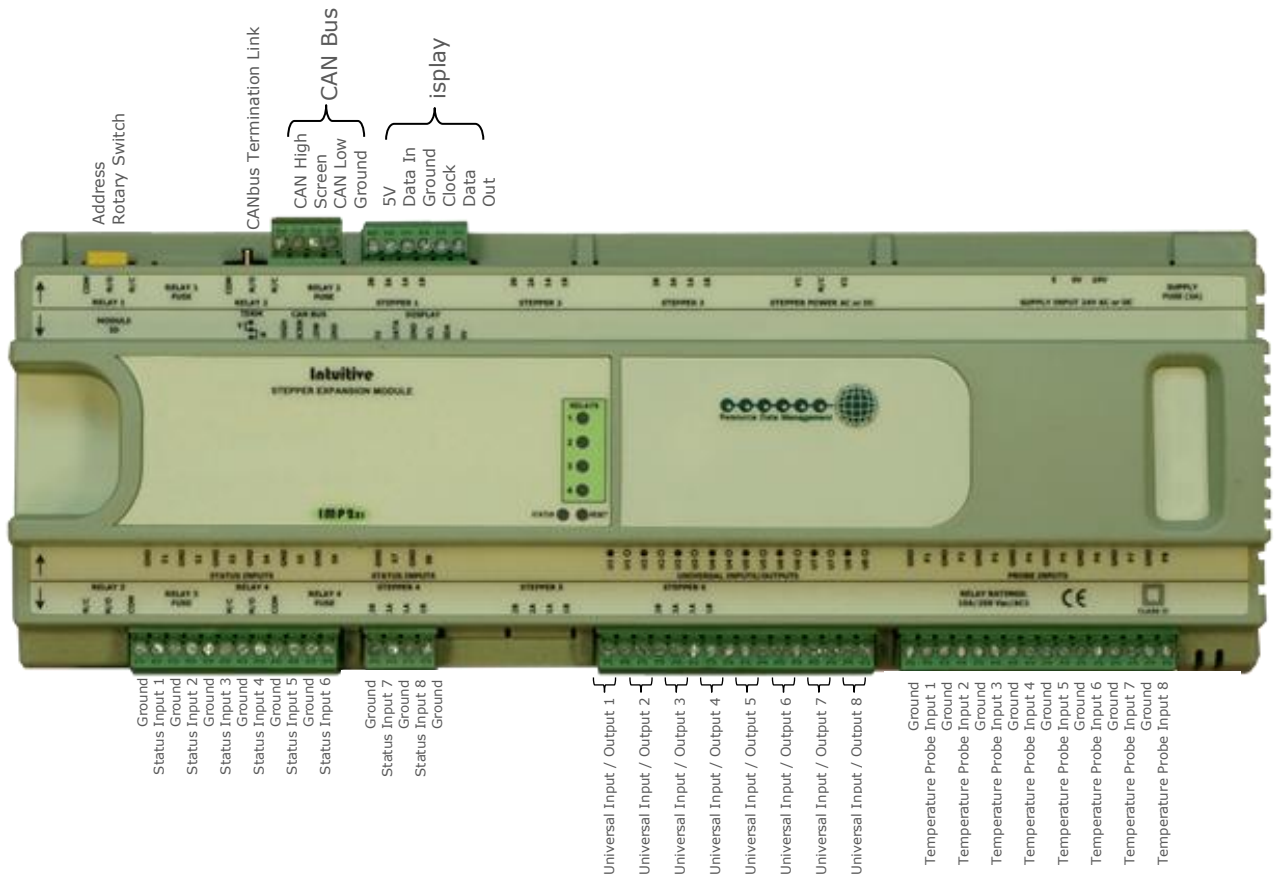

Please ensure all power is switched off before installing or maintaining this product.

Intuitive IO Expansion Board Wiring Connections

PR0661
Bottom Row
Connections

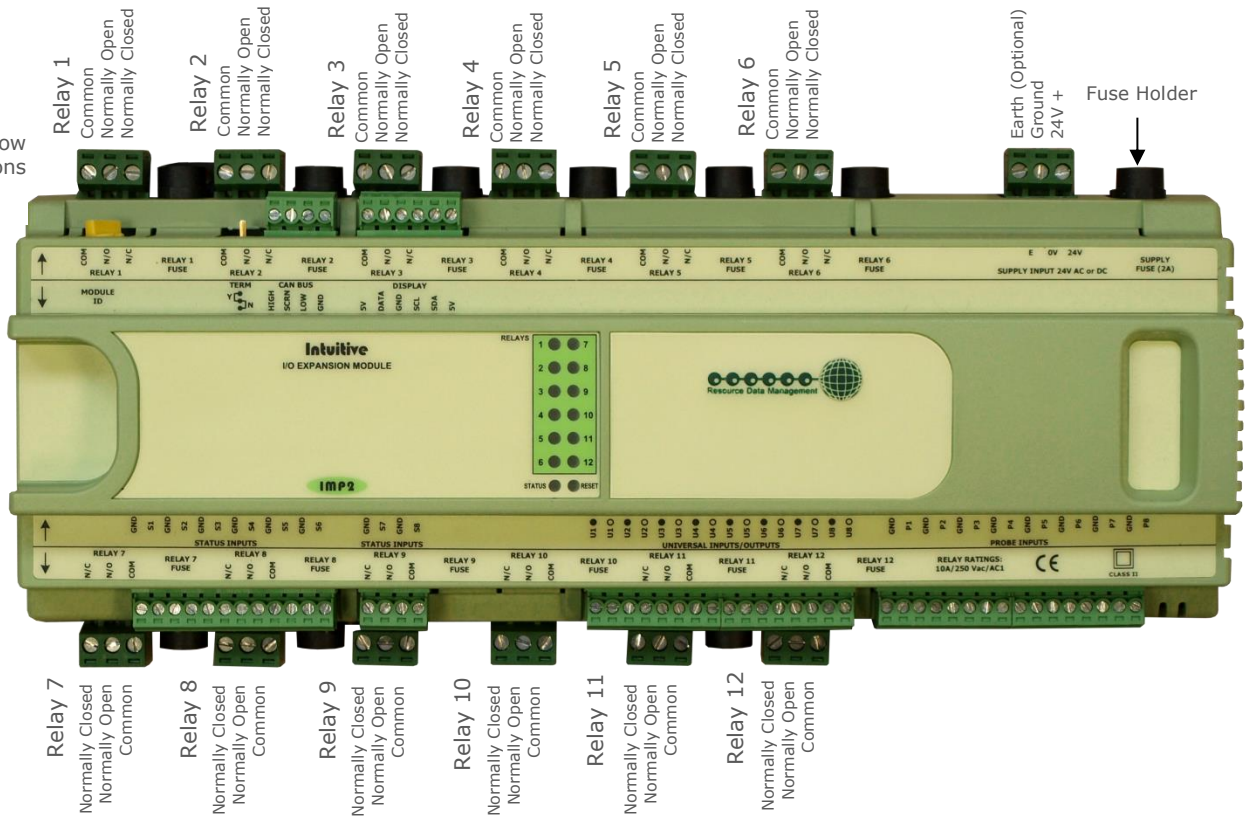

PR0661
Top Row
Connections

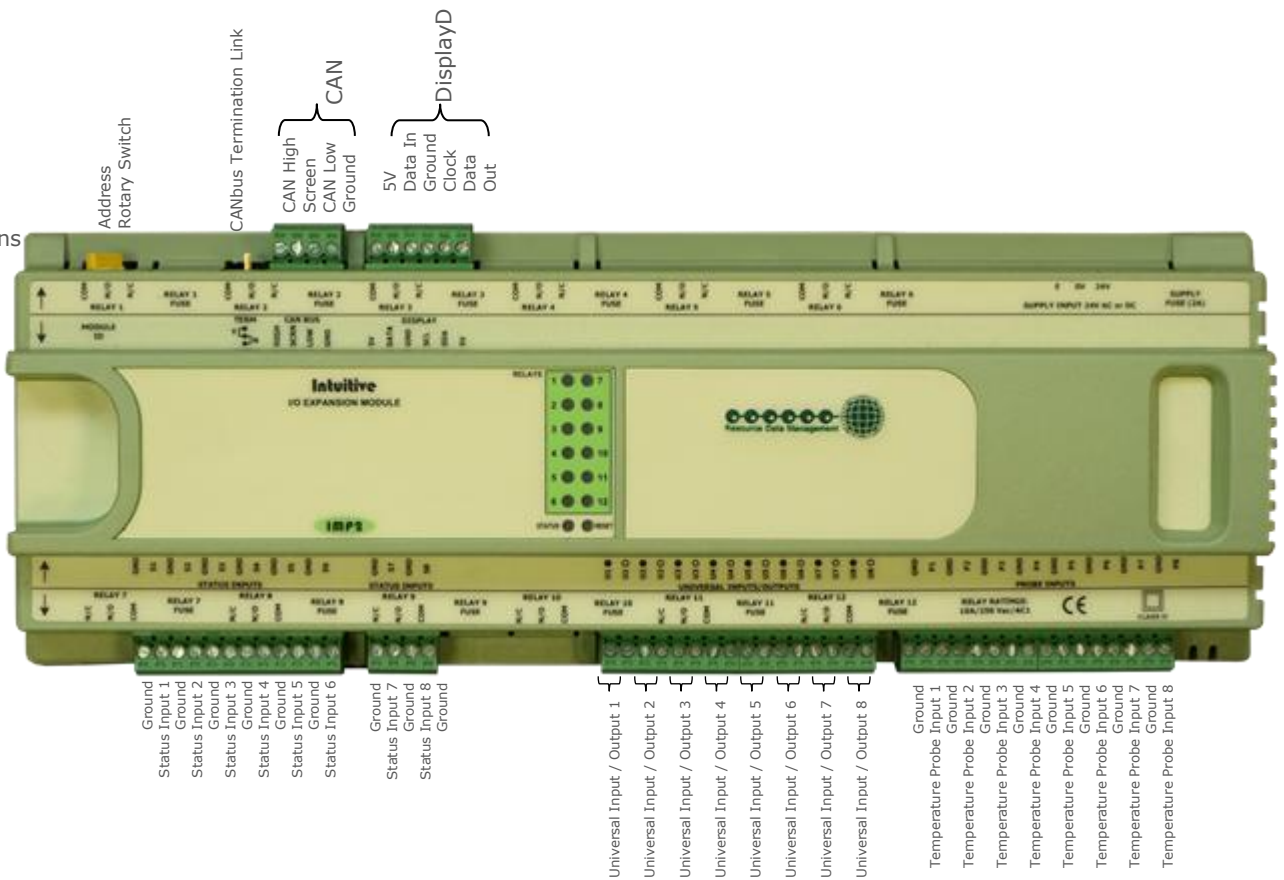

Please ensure all power is switched off before installing or maintaining this product.

Intuitive 48 Input Expansion Board Wiring Connections

PR0662
Connections

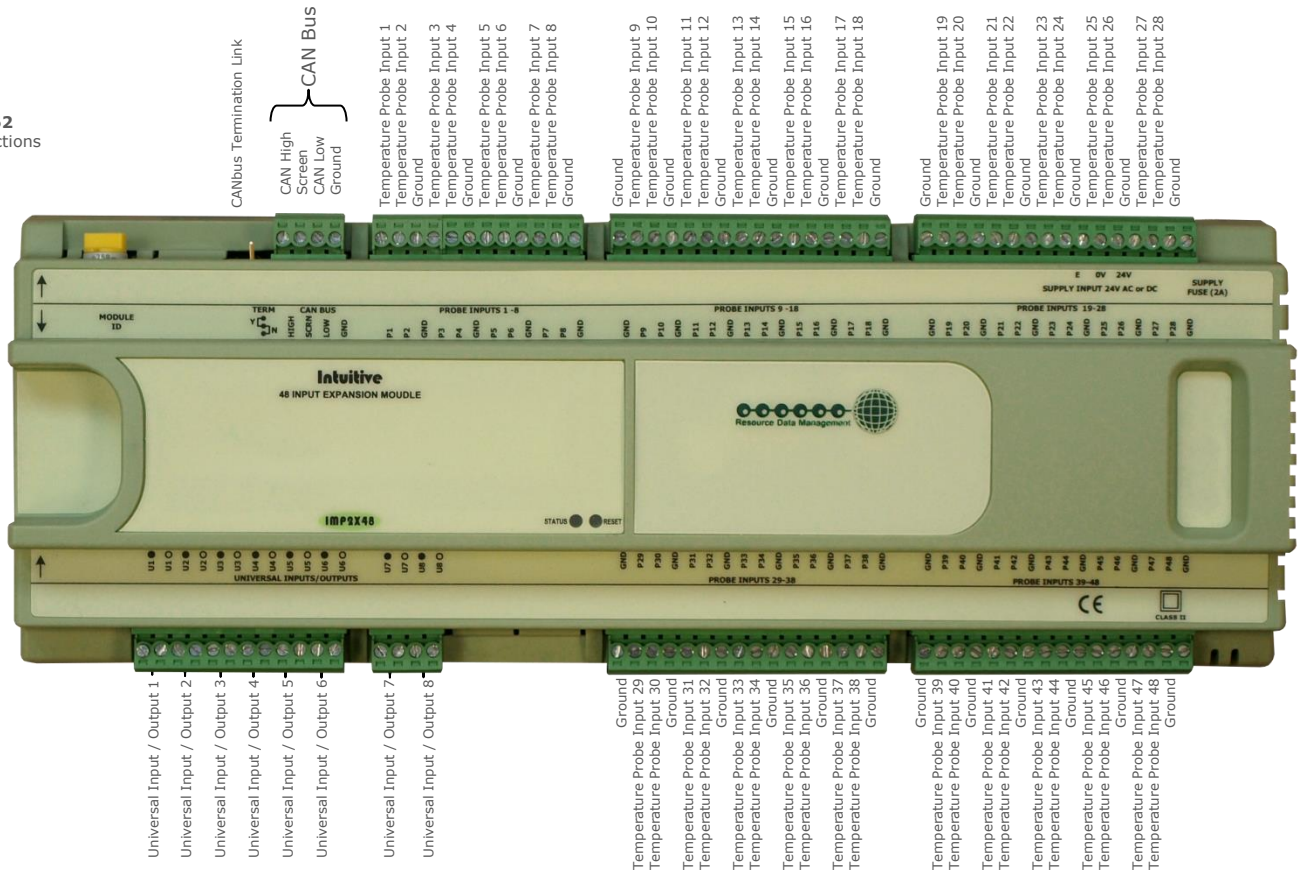

Intuitive Expansion Boards Universal Input / Output Connections

Universal IO Type Configured	Terminal Markings
4-20mA Input	● Sig In ○ 12Vdc Out
0-10V Input	● Ground ○ Signal In



Please ensure all power is switched off before installing or maintaining this product.

Input/Output Table

Input/Output table for Circuit X, where X is a circuit between 1-25. See [Circuit \(Circ\)](#) for viewing controller IO.

Number	IO	Range	Units
I-01	0xA Control Temp	-60.0 to 128.0 (-76.0 to 262.4)	°C (°F)
I-02	0xA Defrost Temp	-60.0 to 128.0 (-76.0 to 262.4)	°C (°F)
I-03	0xB1 C1 Temp	-60.0 to 128.0 (-76.0 to 262.4)	°C (°F)
↓	↓		
I-14	0xM C12 Temp		
I-15	0xB C1 Defrost	-60.0 to 128.0 (-76.0 to 262.4)	°C (°F)
↓	↓		
I-26	0xM C12 Defrost		
I-27	0xB1 C1 Mon	-60.0 to 128.0 (-76.0 to 262.4)	°C (°F)
↓	↓		
I-38	0xM C12 Mon		
I-39	0xA Press	-3.4 to 50.0 (-49.3 to 725.0)	Bar (psi)
I-40	0xA Humidity	0 to 100	%
I-41	0xA Case Clean	0 = Off, 1 = On	
I-42	0xA Manual Defrost	0 = Off, 1 = On	
I-43	0xA Defrost Term	0 = Off, 1 = On	
I-44	0xA Door Switch	0 = Off, 1 = On	
I-45	0xA Man Trap	0 = Off, 1 = On	
I-46	0xA Dual Temp	0 = Off, 1 = On	
I-47	0xA Plant Fault	0 = Off, 1 = On	
O-01	0xA LLV	0 = Off, 1 = On	
O-02	0xA Defrost	0 = Off, 1 = On	
O-03	0xA Fan	0 = Off, 1 = On	
O-04	0xA Trim	0 = Off, 1 = On	
O-05	0xA Lights	0 = Off, 1 = On	
O-06	0xA Hot Gas	0 = Off, 1 = On	
O-07	0xA Remote	0 = Off, 1 = On	
O-20	0xA Trim Percent	0 to 100	%
O-21	0xA Valve Percent	0 to 100	%
O-22	0xA Set Point	-60.0 to 128.0 (-76.0 to 262.4)	°C (°F)
O-30	0xA Last Defrost Time	00:01 to 23:59	hh:mm
O-31	0xA Last Defrost Length	00:01 to 03:00	hh:mm
O-32	0xA Last Defrost Temp	0.1 to 256	°C (°F)
O-33	0xA Last Defrost Type	0= None 1= Internal 2= External 3= Display 4= Timed 5= Forced 6= Skipped	
S-01	0xA Ctrl State	0 = Off 1 = Stabilise 2 = Normal 3 = Pump Down 4 = Df Min 5 = Df Max 6 = Drain Down 7 = Fan Delay 8 = Recovery 9 = OT Alarm 10 = UT Alarm 11 = Case Off 12 = Ctrl Fail	



Please ensure all power is switched off before installing or maintaining this product.

Override

The override function allows the user to switch output stages on or off and operates on Main board only. Press the Override and Enter button together for approx 3 seconds until "t-01" is displayed.

Use the "up" or "down" button to scroll through the available boards (t-01 to t-012) and press enter to scroll through the available relays (r-01 to r-12) and 4-20mA outputs (A-01 and A-02)
 For (r-01 to r-12) Press "Enter" and select "1" to turn the relay on and "0" to turn the relay off.
 For (A-01 and A-02) Press "Enter" and use up and down buttons to select the output on 4-20mA outputs 1 and 2 0% to 100%
 Override will last for 30 seconds then the output will return to normal operation.

Display Messages

The following messages can appear on the display during normal operation.

Display	System status
Ot	Case Over Temperature
Ut	Case Under Temperature
Ft	Control probes faulty
dEF	Circuit in Defrost
CASE OFF	Circuit in Case Off

During normal operating conditions the Circuit controller display will cycle through the configured Circuits. The current circuit number will be shown on the left hand side display and at the same time the control temperature for the corresponding circuit will be shown on the right hand display. An example is shown below.



If an OT alarm occurs on a Circuit then the display will show the Circuit number on the left hand side and the message "Ot" on the right hand display for around 1 second (Figure 1). After a 1 second delay the right hand display will show the OT temperature (Figure 2). A similar process is shown for circuits in Defrost and circuits with UT alarms.

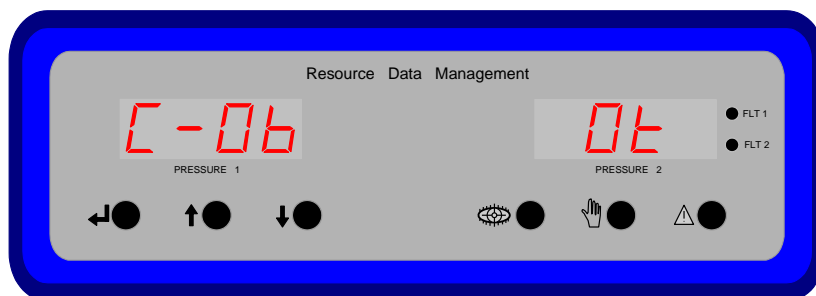

Figure 1 – OT message



Please ensure all power is switched off before installing or maintaining this product.

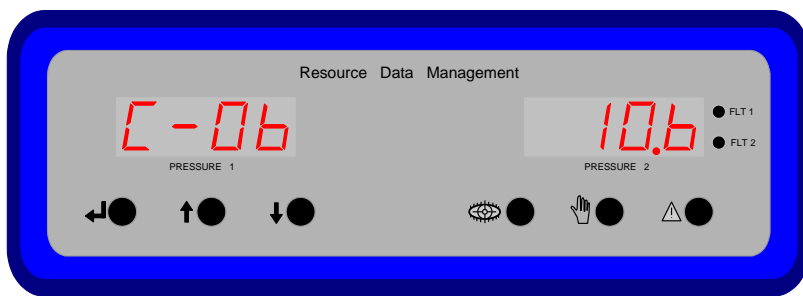

Figure 2 – OT Temperature

If a Circuit is placed into Case Clean then the display will show the Circuit number on the left hand side and the message “CASE” on the right hand display for around 1 second (Figure 3). After a 1 second delay the right hand display will show “OFF” (Figure 4).

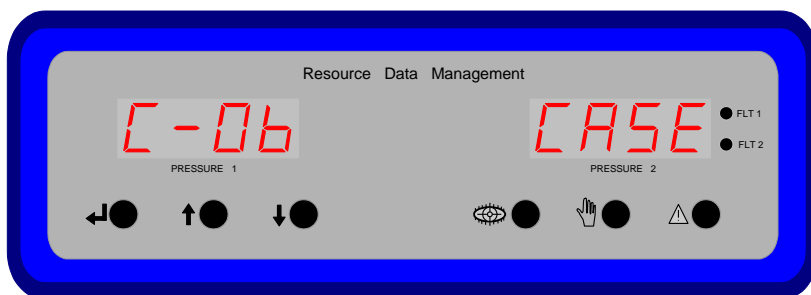

Figure 3 – Case Off

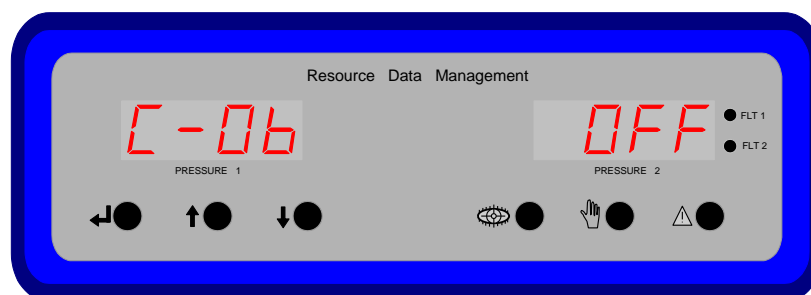

Figure 4 – Case Off

Network Alarms

The table below shows the text and associated type number that is sent to the system “front end”. The type number is normally used to provide different alarm actions.

xxx will be replaced with 01 to 25 depending on circuit in alarm. y will be replaced with the probe number

xxx will be replaced with the Circuit and y will be replaced with the Expansion board number which has dropped offline.

Alarm text	Type #
xxx Probe y Fault	6
xxx Case y OT	4
xxx Case y UT	5
xxx Plant Fault	3
xxx Board y Offline	7
xxx Man Trapped	14



Please ensure all power is switched off before installing or maintaining this product.

Setup via a PC

Log on to the RDM web site and go to Support -> Software.

Download the following folder: - Circuit Controller USB drivers for Windows XP/2000. Contained within this folder are installation instructions and the drivers required to connect to the Intuitive Circuit controller. A USB cable is required which connects to a Type A USB connector (PC) at one end and a Type B USB connector at the other end (Plant USB Device port).

Log in using an appropriate username and password; setup operations can then be used via the PC by clicking on the appropriate link: -

Control

This page allows you to view values, settings, alarm log or set parameters of the Circuit controller: -

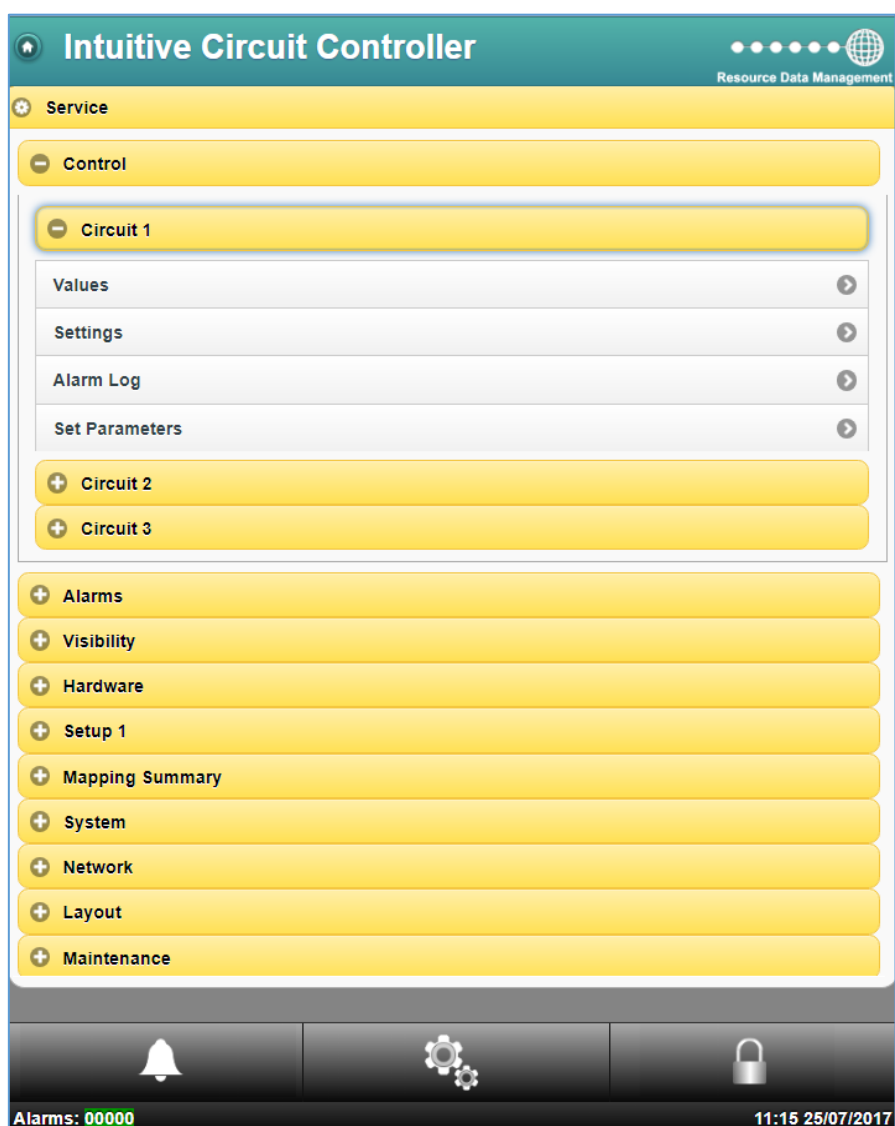

Link	Operation
Control	
Values	Shows the values being returned on the controllers inputs and outputs
Settings	Shows the controllers parameter settings
Alarm Log	Shows the controllers alarm history; up to 1000 alarms are stored
Set Parameters	Allows the user to change parameter values



Please ensure all power is switched off before installing or maintaining this product.

Alarms

Link	Operation
Current Alarms	Shows the current alarms for all sections.
Old Alarms	Shows the historical alarms for all sections

Visibility

To simplify the appearance of the controller when being viewed with a PC or TouchXL, devices, items, alarms and display values can be hidden or renamed using the Aliases section.

Link	Operation
Device Name Alias	Allows devices to be hidden or renamed such as Circuit 1, Mainbrd, Setup1, ExtBrd1. For example Circuit 1 can be renamed or hidden if not used.
Device Item Alias	Allows items within a device to be renamed or hidden such as 01A Ctrl Temp, this can be renamed to "BAY A Temp" for example or hidden if not used.
Device Alarm Alias	Allows the description of any alarm to be changed, for example 01A Probe Fault 1 can be renamed to "BAY A Control Probe Fault" or hidden if not used.
Index Page Display	Allows the user to configure the Inputs (max 30), Outputs (max 60) and States (max 3), that are shown on the homepage.
Active Alarms	Shows a complete list of alarms that can be generated by the Circuit Controller
Hidden Alarms	Shows a list of alarms that are hidden / disabled

If items are aliased or hidden this will only apply to the controller when viewed directly, all values will be shown when connected to a Data Manager, the Data Manager has its own aliasing page which can be used if required.

To set an alias back to factory setting leave the required field blank and then set aliases.

Hardware

The Main Board drop down, within the Hardware menu permits the user to; view the real time I/O values being returned, view the current settings for the I/O, view the associated alarm log and the option to set the configuration of the Main Board. An example of the real time I/O is shown below;

If the user enters the 'Set Parameters' section, it will allow all the Main Board's I/O to be configured, similar to below;



Please ensure all power is switched off before installing or maintaining this product.

Link	Operation
Values	Shows the values being returned on the main controllers inputs and outputs
Settings	Shows the main controllers configuration settings
Alarm Log	Shows the controllers alarm history; 1000 alarms are stored
Set Parameters	Set the Universal IO, Invert Relay and Probe Offset configuration of the Main Board

ExtBrd 1-10

The Extension Board’s hardware set up uses the same method as described in the ‘Main Board’ section above. The one difference refers to the first parameter; “Board”. This option allows the user to detail what board type is being used in this position; select between an IO Expansion Board , Stepper and a 48 channel board.

Setup

This page allows the user to set how many circuits are being used, probe type, pressure type, external devices, screen dev and web interface.

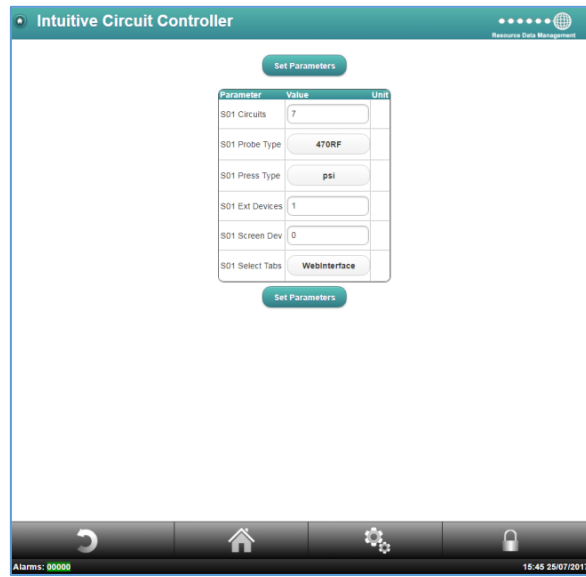

Mapping Summary

This allows the user to see where the input and outputs are set on the controller for each enabled circuit.



In the example above:
01B C1 Temperature probe is wired into Mainboard Probe 1



Please ensure all power is switched off before installing or maintaining this product.

System

This page allows you to view System Log, mute and clear alarms, clear aliases, current features, Network info, Time, Reset, Version and Touch XL Status.

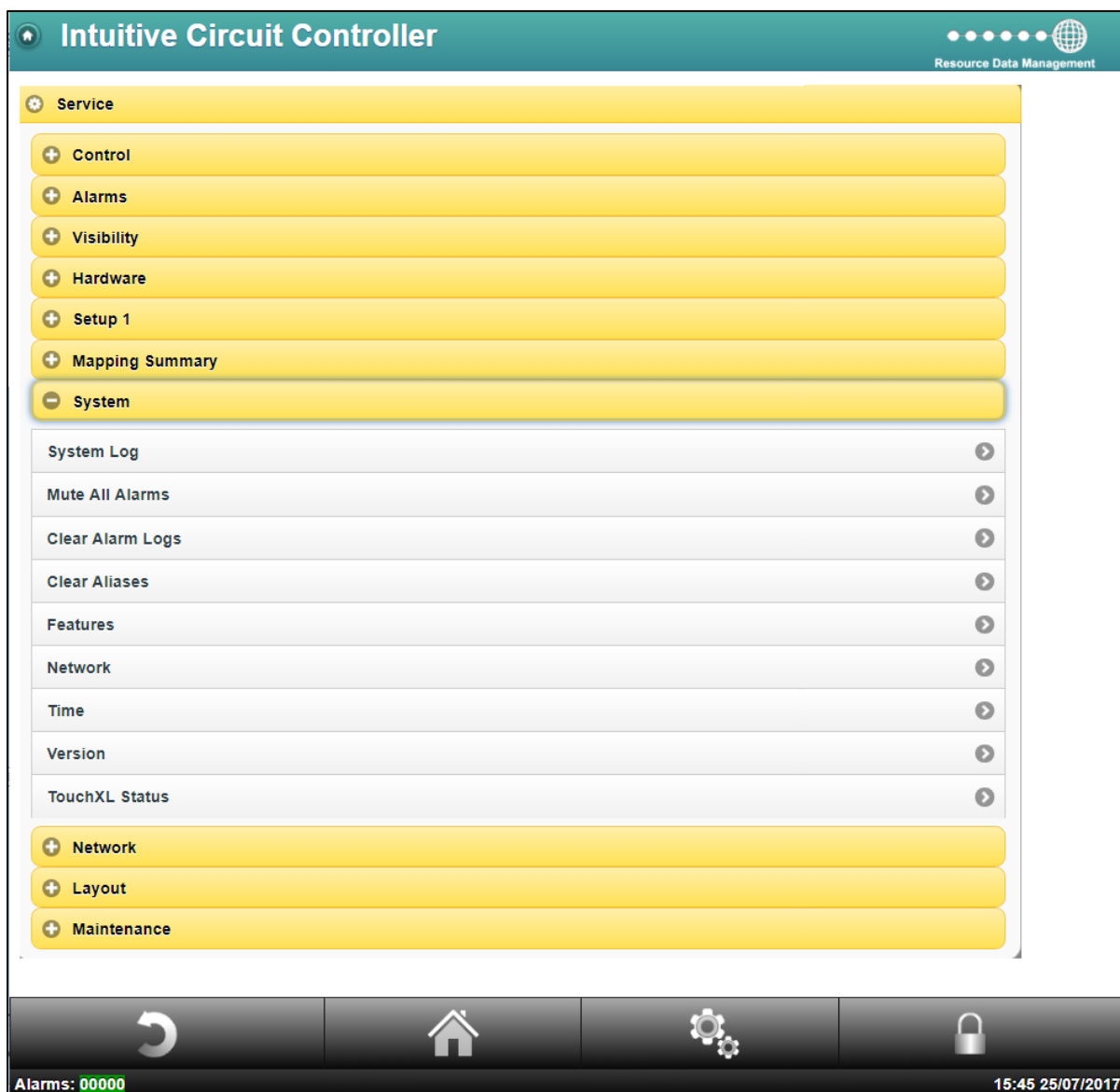

Link	Operation
System Log	Displays the changes made to the controller in chronological order.
Mute All Alarms	Silences all unacknowledged alarms (Yes/No choice).
Clear Alarm Log	Clears the controller alarm log completely (Yes/No choice).
Clear Aliases	Clears all aliases that have been assigned IO. Additionally clears the visibility of sections and IO's.
Features	Displays what features have been enabled on the controller.
Network	Setup: - Rotary Switches (information only) IP Address Netmask Default Gateway
Time	Set the Time or synchronise with the PC.
Version	Shows the controller and expansion board's software version.
TouchXL Status	Displays the IP Address, MAC Address, Name and status of the TouchXL (if connected).



Please ensure all power is switched off before installing or maintaining this product.

Layout

Manage Layouts

The Circuit Controller provides the option for users to upload layouts. Utilising RDM's Layout Editor software, users can generate their own layout to represent the control strategy in the device. Please consult RDM Technical Support for more details on the Layout Editor. The below shows an example of such a layout;

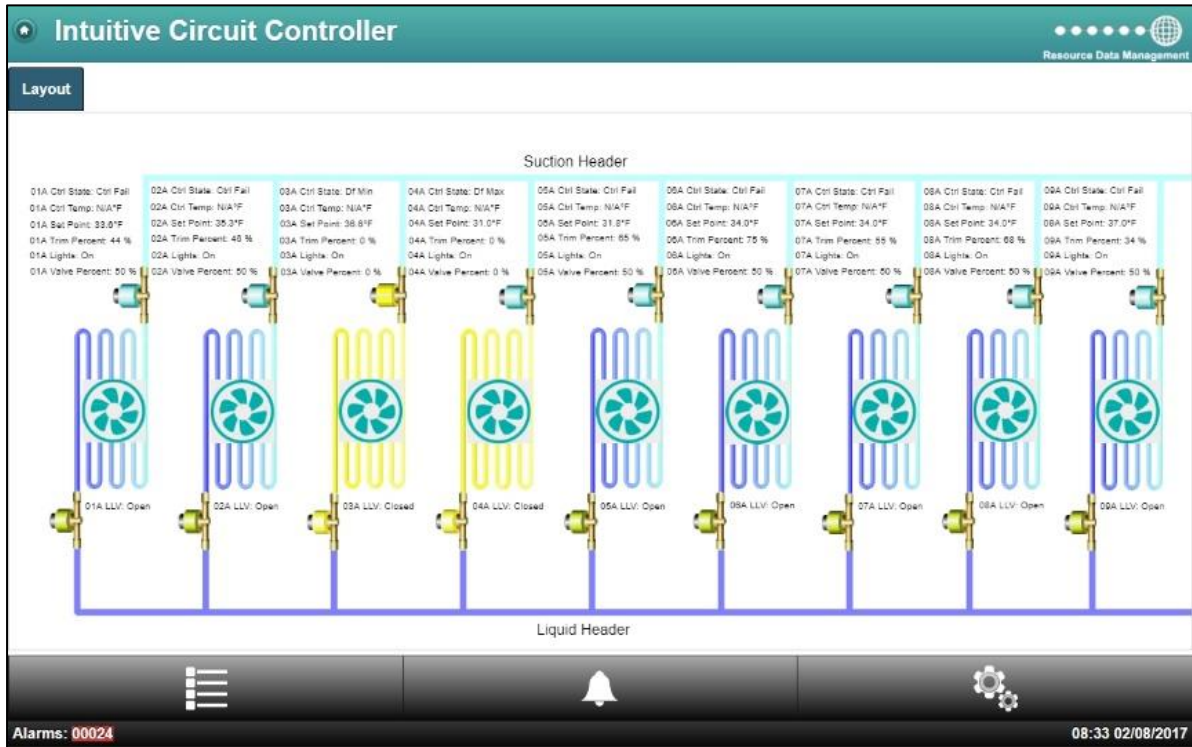

Link	Operation
Configure	Allows the user to provide a description of the Layout
Set Default	Not used in this variant.
Get	This option allows the layout to be download to the user's PC.
Remove	Select this option to permanently remove the layout from the Circuit Controller. Note: Once removed the layout cannot be recovered.
Preview	Use this option for a quick view of the selected layout without leaving the setup page.

Note: The current Circuit controller hardware will support a dynamic image which will only allow one level at a maximum size of 1MB.

When updating or replacing a layout the web browser cache may need to be cleared on the PC being used to view it.



Please ensure all power is switched off before installing or maintaining this product.

Maintenance

Link	Operation
Main Config	Allows the configuration of the controller setup. (See information below)
Save Config	Use this option to save the Circuit controller configuration to a file
Load Config	Use this option to load the Circuit controller configuration to a file
View Config Info	Provides information on the last loaded configuration file and any mismatches
Add Feature	This is a utility to enable features that are currently disabled.
Reset	This allows the user to reset the controller.

Main configuration screen

Control Type: Cannot be changed.

IP 1 - IP 9: Current IP address, netmask and gateway.

Static id: If rotary switches have been set to 000 this can be used as the broadcasting id.

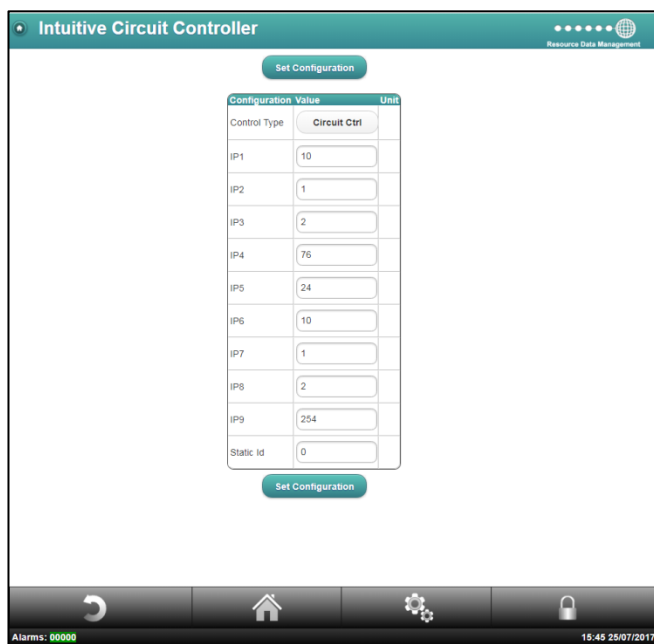

Please ensure all power is switched off before installing or maintaining this product.

Remote Commands

The following commands can be used by a Data Builder program running on a Data Manager to send commands to the Circuit controller

Command	Value to send	Description	Conditions
Def Cmd	1	Initiates a defrost cycle	Defrost mode: remote
Def Cmd	3	Terminates the defrost	Defrost mode: remote Defrost hold: On Defrost min state complete
Trim Cmd	0 to 100%	Sets the trim level to this value (Trim period is 5 minutes)	
Setpoint Cmd	+/-24	Is added to or subtracted from the setpoint	
Case Cmd	5	Sets the controller to Case Off	
	0	Restores the controller from Case Off to Normal	

Use an "Analogue Out" block configured to the controller name and in the value field type in the command you require. Use a "Setting block" as the input to the "Analogue Out" block to send the Value.

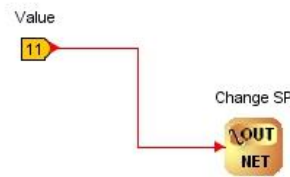

See Example on the right, which increases the setpoint 01A on controller 123 by 11 degrees.

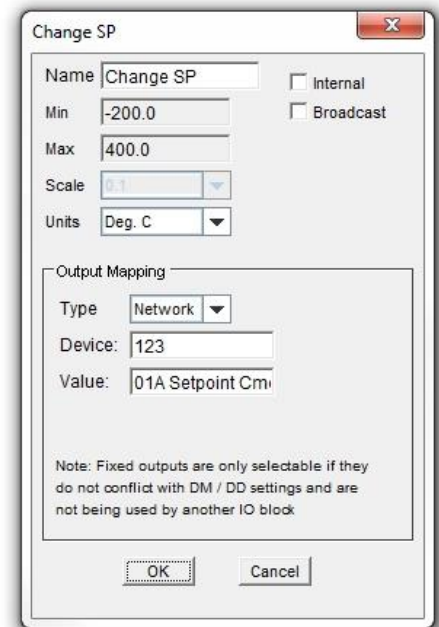

Please ensure all power is switched off before installing or maintaining this product.

Specification

Power requirements:

Supply Voltage Range:	24 Vac $\pm 10\%$ or 24 Vdc $\pm 10\%$
Supply Frequency:	50 – 60 Hz $\pm 10\%$
Maximum supply current:	<1 Amp
	Typical supply current: <1.0 Amp

Class 2 Insulation: **No** protective Earth is required. A functional earth can be connected if the equipment is located in an electrically noisy environment.

Note : The use of centre tapped to earth transformers is not allowed. This is to prevent damage to the transformer and/or controller.

The host equipment must provide adequate protection against contact to hazardous live parts.

RDM advise the use of a suitable external over-current protection device.

Warranty may be invalidated due to excess current being unlimited if there are no fuses/circuit breakers installed

General

Operating temperature range:	-10°C to +60°C
Operating Humidity:	80% maximum
Storage temperature range:	-20°C to +65°C
Environmental:	Indoor use at altitudes up to 2000m, Pollution Degree 1, Installation Category II. Voltage fluctuations not to exceed $\pm 10\%$ of nominal voltage
Size:	Intuitive Circuit Controller 280mm (L) x 122mm (W) x 67mm (H)
Weight:	Intuitive Circuit Controller 750 Grams
Safety:	EN61010
EMC:	EN61326; 1997 +Amdt. A1; 1998
Ventilation:	There is no requirement for forced cooling ventilation

Inputs:

Probe Input type

See [Set/change Units](#) for probe types

Digital Input type

The preferred option is a 0 volt return through a volt-free relay or 24 Vac referenced to the supply voltage. If a 24Vac signal is being sourced from the Circuit controller power supply then **do not** ground the Digital Input common rail, this is grounded internally. See [Appendix 03](#)

4-20mA

4-20mA current loop, use the 12 Vdc output to feed the device.

Analogue Outputs

0-10 Volts DC or 4-20mA. (Selected in the properties box of the output block)

Note 1: The 4-20mA output will not operate correctly if the target device input impedance is $> 75\Omega$

Note 2: The 0-10V output will not operate correctly if the target device input impedance is $< 10K\Omega$ A 50mA fuse is recommended for this output.

Note 3: On the Intuitive controller, when using the universal 0-10V output to drive an inductive load such as a relay coil, a back e.m.f. protection diode must be fitted. The cathode should connect to the output terminal and the Anode to GND/Return terminal. The maximum load current that can be supplied from these outputs is 38mA.



Please ensure all power is switched off before installing or maintaining this product.

Relay Ratings

Intuitive Circuit Controller

10A/250 Vac/AC1 (Resistive load)
 10A/30 Vdc (Resistive load)
 5A/250 Vac cosφ=0.4
 Lifespan approximately 200,000 operations.

Fuse Ratings, Intuitive Circuit Controller

Relay Fuses 10A Antisurge HRC, 32 x 6.3mm
 Supply Fuse 2A Antisurge HRC, 32 x 6.3mm

Software, Software drivers and software features and function licences

RDM product Software Licences and drivers are non-transferable. They are purchased with hardware or separately and once added to hardware for use on that hardware only. If hardware is returned and deemed out of warranty all software driver licences terminate with the hardware.

Comms: Ethernet or RS485 Bacnet

Interboard Comms CANBUS

CANBus cable specification:

CANBus communication cable **must** be of a standard to meet ISO11898 or equivalent and the screen connection **must** be used.

Note end of line termination resistors must be fitted on the CANBUS network. One resistor should be fitted at the Intuitive Circuit controller CANBUS network connector across the CAN High pin and the CAN Low pin. The second should be fitted to the last Expansion board on the CANBUS network and must be fitted across the CAN High pin and the CAN Low pin. The termination resistor value required is a 120Ohm and must have a tolerance of +/- 1% or better. The network should be wired in a daisy chain configuration. Only one Circuit controller should be connected to a single CANBUS network. The maximum allowable network cable length is 500M in total from one end of the network to the other providing a CANbus network cable which meets ISO11898 or equivalent is used.

When connecting an expansion board to either the Intuitive Circuit controller or another Expansion board the following should be observed.

<u>Circuit Controller/Expansion Board</u>		<u>Expansion Board</u>
CAN High	Connects to	CAN High
Screen	Connects to	Screen
CAN Low	Connects to	CAN Low
Ground	Connects to	Ground

End of line termination resistor / link



Please ensure all power is switched off before installing or maintaining this product.

The Intuitive range has end of line termination resistor links which should be fitted to the middle and bottom pins on the Main control board and on the last expansion board on the CANbus network. All other expansion boards should have the link removed or fitted to the middle and top pins.

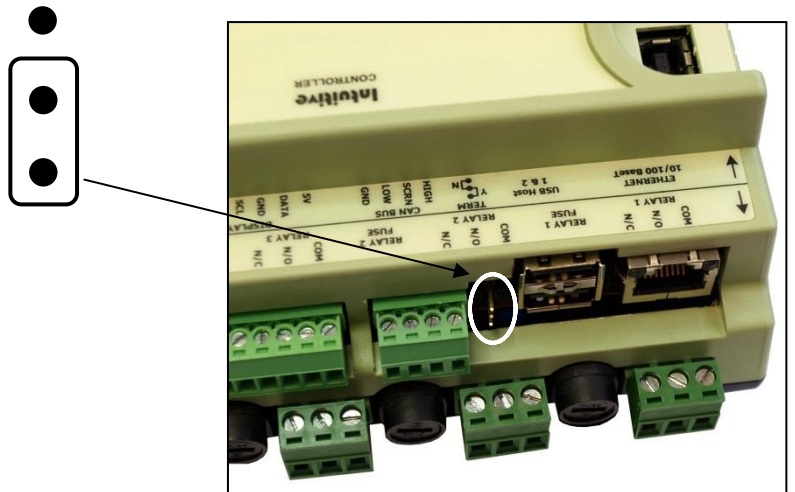

Clearances:

The controller must have 10mm clearance above the top and 15mm clearance from the sides. Clearance at the front and rear is dependent on the site wiring. There is no requirement for forced cooling ventilation.

Cleaning:

Do not wet the controller when cleaning. Clean the front by wiping with a slightly dampened lint free cloth.

Disclaimer

The specifications of the product detailed in this document may change without notice. RDM Ltd shall not be liable for errors or omissions, for incidental or consequential damages, directly or indirectly, in connection with the furnishing, performance or misuse of this product or document.



Please ensure all power is switched off before installing or maintaining this product.

Appendix 1 Defrost Cycle

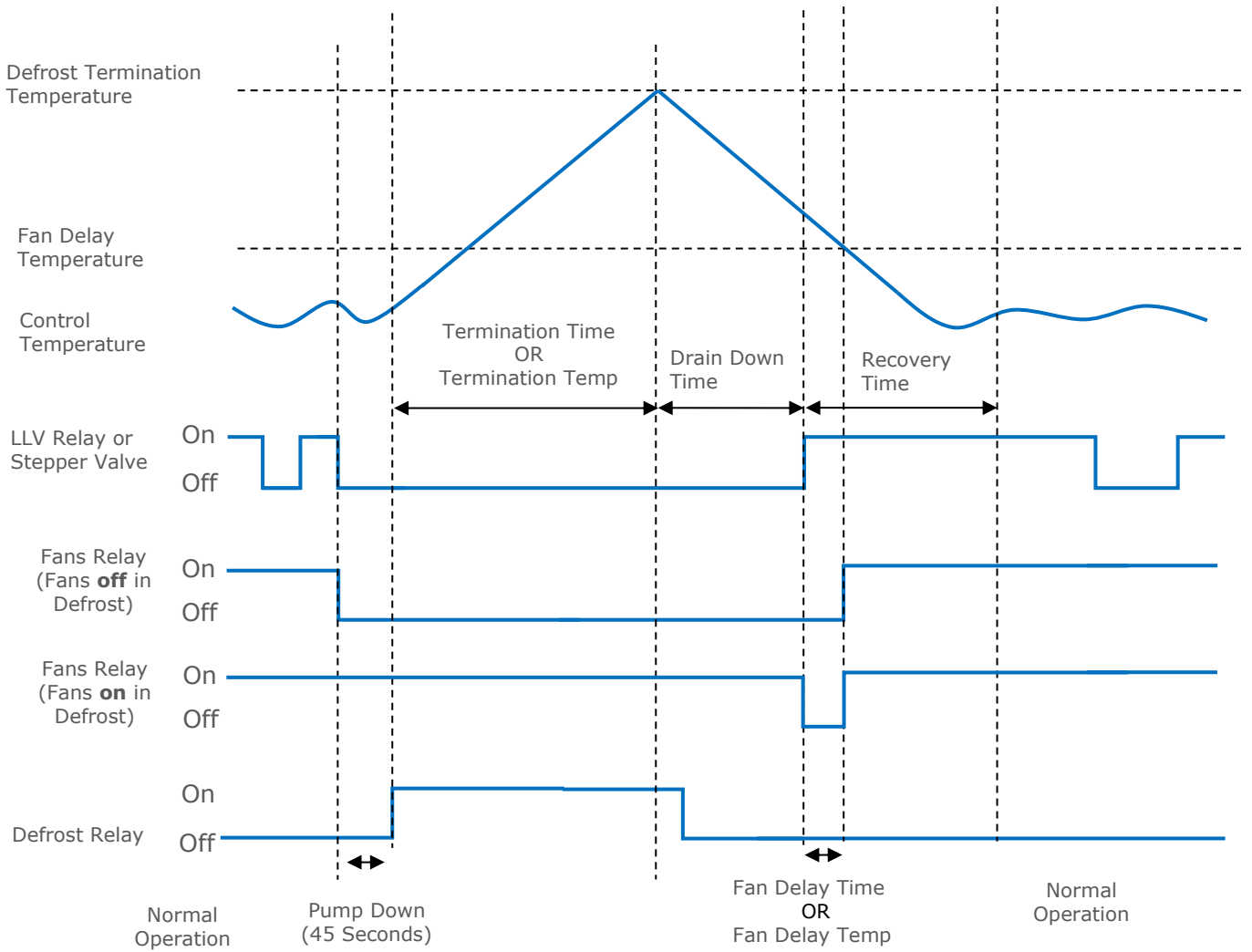

Please ensure all power is switched off before installing or maintaining this product.

Appendix 2 – Supply & Status Input Wiring

Appendix three applies to the current version of the Circuit controller hardware.

Method 1. Uses the 24Vac of the transformer supplying the input voltage; which is returned via a switch (or relay) to the status input signal line. No 0V is required at the status connector.

Method 2. Uses a 0V return (from the status connector) to the status signal input.

Method 3. Uses a 24Vac signal derived from another transformer (supplying an auxiliary piece of kit) to feed the status input signal line

All transformers that have a connection to the Circuit Controller must have their primaries connected to the same phase. Transformer should have fuse fitted in line with 24V input as per diagram.

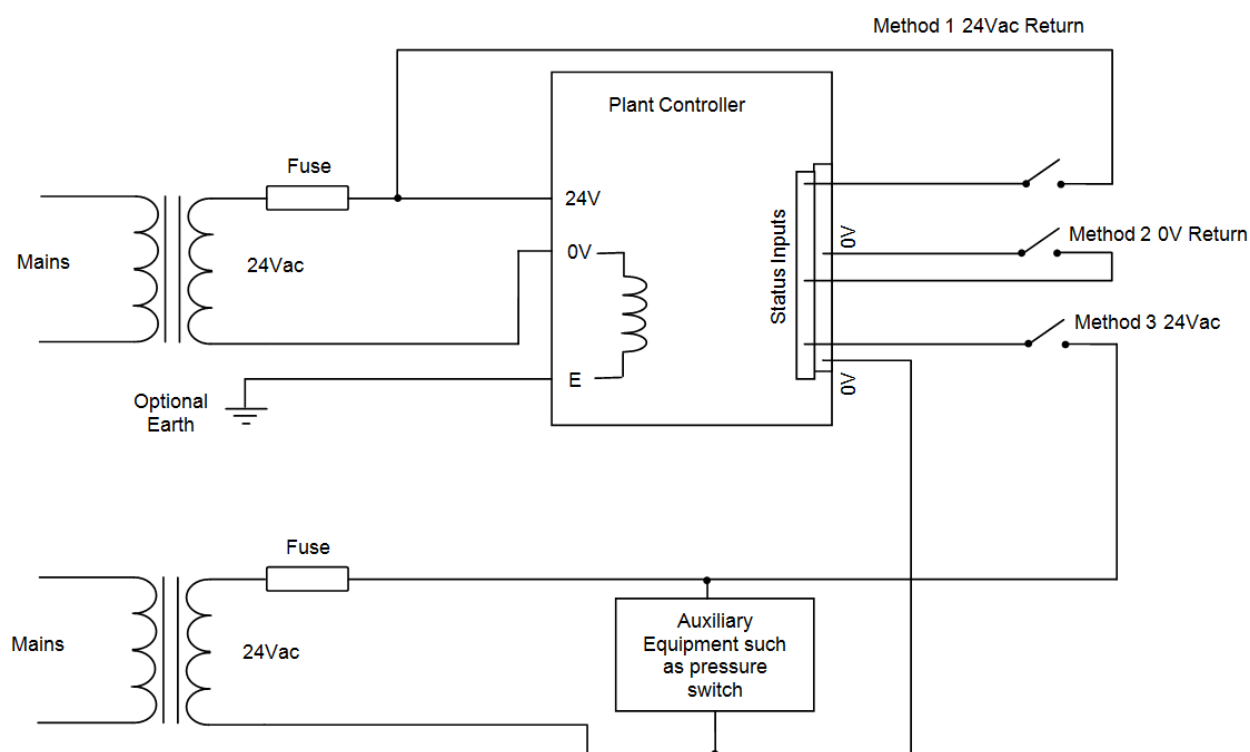

Please ensure all power is switched off before installing or maintaining this product.

Revision History

Revision	Date	Changes
1.0	21/04/2010	Draft Issue
1.2	05/05/2010	1 st Release (Software and User Guide revision harmonised)
2.2	24/02/2012	Current Issue (Issue synchronised with software version)
2.3	05/11/2012	Individual alarms on probes and new numbers for circuits
2.5	29/10/2013	Monitor probe support added
2.6	21/02/2014	Remote TDB commands added, images updated.
2.9	09/07/2014	Intuitive Variant added, expansion board settings added, specific stepper type removed, step reset time added
3.0	03/09/2014	Operation of secondary set point modified.
3.0b	06/01/2014	Operating temperature range updated.
3.4	30/10/2015	Ability to disable probes and default variable input changed to 0-10v
3.7	19/07/2016	Fixed pump down period of 45 seconds added before df min.
3.7a	20/12/2016	Update to specification page
3.7b	24/03/2017	Update to Stepper expansion image
3.8	10/05/2017	Parameter ordering modified.
3.9	21/08/2017	New cgi, TouchXL support added, defrost skip added, support for PR0652 added, layout support added, parameter numbers changed, Additional 1-2 vdc and 1-6 vdc analogue input, RDM-485 support and auto split feature.
4.0	13/09/2017	Stepper mA settings changed, SEI 6 valve added, overdrive description updated.
4.1	29/11/2017	Temperature unit descriptions altered.
4.2	13/02/2018	Revision level updated to keep in line with the V2 platform



Please ensure all power is switched off before installing or maintaining this product.

Group Offices

RDM Group Head Office

80 Johnstone Avenue
Hillington Industrial Estate
Glasgow
G52 4NZ
United Kingdom

+44 (0)141 810 2828
support@resourcedm.com

RDM Inc

100 North Sixth Street
Suite 630B
Minneapolis, MN
55403
United States

+1 612 354 3923
usasupport@resourcedm.com

RDM Asia

Sky Park at One City
Jalan USJ 25/1
47650 Subang Jaya
Selangor
Malaysia

+60 3 5022 3188
info@rdmasia.com.my



Visit www.resourcedm.com/support for more information on RDM solutions, additional product documentation and software downloads.

While every effort is made to ensure the information given within this document is accurate, Resource Data Management Ltd shall not be liable for errors or omissions, for incidental or consequential damages, directly or indirectly, in connection with the furnishing, performance or misuse of this product or document. All specifications are subject to change without notice.

See www.resourcedm.com for terms and conditions of sales.

Copyright © Resource Data Management