

Mercury 6-5 I/O Module Low Voltage version Installation Guide



For Product: -

PR0451



Ensure that all power is
switched off before
installing or maintaining
this product

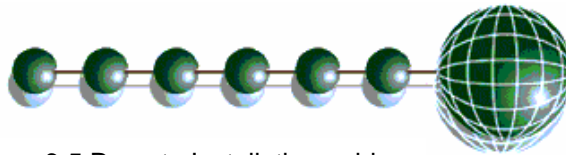

Table of Contents:

THE MERCURY RANGE 3

Description 3

Configuration 3

Networks..... 3

Connections 4

Input/Output Allocation Tables 4

Setting up the controller 5

 Set-up Mode..... 5

 Set-up through front buttons 5

 Set-up Function Menu..... 5

Recommended set-up method 6

 rtc. Real time clock (This will automatically synchronise on network systems) 6

 PArA. Set/view parameters (This can be achieved at the network front end) 6

Parameter Table:..... 6

 Parameter table for I/O Module..... 6

Network Configuration 7

 485 Legacy module..... 7

 Fast Network Address Reset 8

 IP Futura module..... 8

 IP-L 8

 IP-r..... 9

Normal Operation 9

Viewing 9

 Input/Output table for Remote Module..... 9

Display Messages..... 9

Remote Commands 10

Specification 11

 Power requirements:..... 11

 Relays 11

 Inputs: 12

Installation:..... 12

 Fixing:..... 12

 Clearances: 12

Cleaning: 12

Appendix 1 13

 Using the I/O module with the Data Builder (Controller Editor) Program 13

 Analogue Input block properties: 13

 Digital Output Block properties 14

 Analogue Output Block properties 14

 Control State Values: - 14



Ensure that all power is switched off before installing or maintaining this product

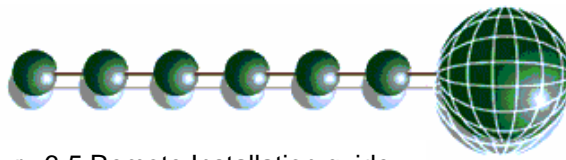

The Mercury Range

From Resource Data Management

This documentation refers to the Low Voltage Mercury I/O Module

Description

The Mercury I/O module is intended for use with the Data Builder Program, to access networked I/O. There is no functional program inside the I/O module, its inputs and outputs are all available to be used as remote I/O by the Data Builder (See Controller Editor in appendix 1)

Each input has to be locally configured before use, see parameter table for set-up options.

When an input is configured for probe use, a switched resistor can be used as a digital switch on that channel.

The I/O module supports PT1000, NTC2K and NTC2k25 probes.

Configuration

The I/O module is delivered pre-configured with all 6 input channels as PT1000 probes.

Networks

The controllers are capable of connecting to either a TCP/IP local area network or a RS485 network or controlling in standalone mode with no network output.

To connect to a network you must add the correct communications module.

- 485 Legacy module (Part No PR0026)
- IP Futura module (Part No PR0016)

Connecting to either of these communication modules will automatically be detected on power up and this will affect the set up screens made available to you.



Ensure that all power is switched off before installing or maintaining this product

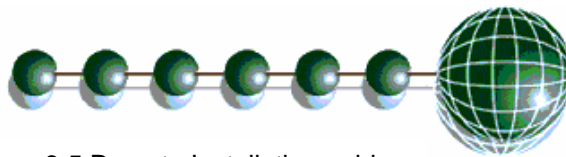

Connections

All connections are made to the back of the controller. The diagram below shows the connection detail. Inputs and outputs are assigned according to the chosen configuration. See [Specification](#) for further details on connections.

Inputs:

- Pin 1: Ground
- Pin 2: Input 1
- Pin 3: Input 2
- Pin 4: Ground
- Pin 5: Input 3
- Pin 6: Input 4
- Pin 7: Ground
- Pin 8: Input 5
- Pin 9: Input 6
- Pin 10: Ground

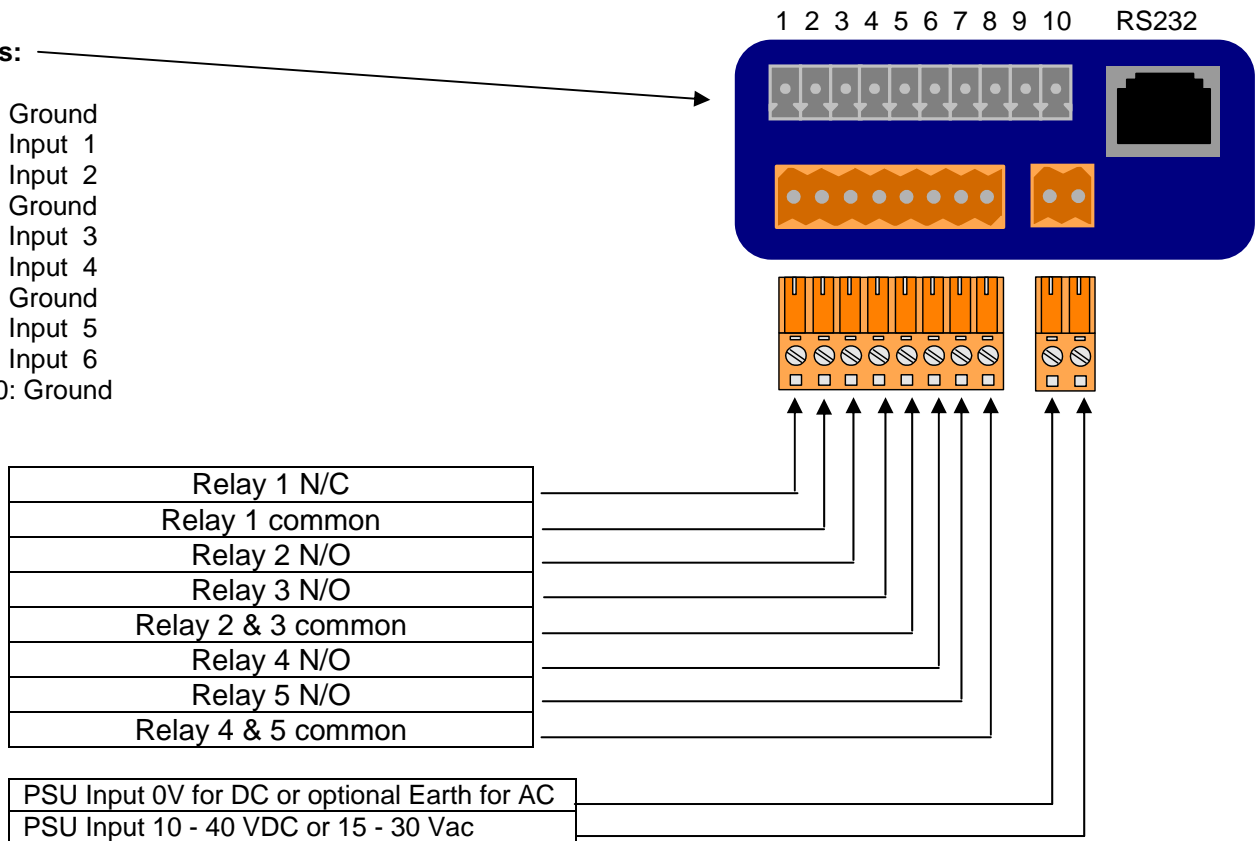

Input/Output Allocation Tables

Monitor	Description	Alarm Action	Switch Function (resistor*)
Input 1	Probe or Plant	Yes	Yes when in probe mode
Input 2	Probe or Plant	Yes	Yes when in probe mode
Input 3	Probe or Plant	Yes	Yes when in probe mode
Input 4	Probe or Plant	Yes	Yes when in probe mode
Input 5	Probe or Plant	Yes	Yes when in probe mode
Input 6	Probe or Plant	Yes	Yes when in probe mode
Relay 1	N/C relay	N/A	N/A
Relay 2	N/O relay	N/A	N/A
Relay 3	N/O relay	N/A	N/A
Relay 4	N/O relay	N/A	N/A
Relay 5	N/O relay	N/A	N/A

* For PT1000 probes, use 820 Ohm switched resistors
 For NTC2K and NTC2K25 probes, use 590 Ohm switched resistors

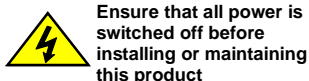

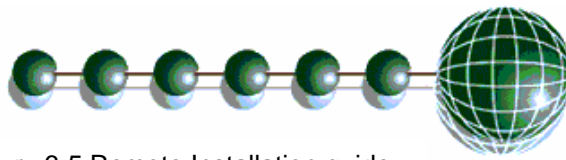

Setting up the controller

Access to the controller can be achieved several ways

- Through the front mounted buttons
- Direct access by PC or palm top into the rear comms port. This requires a software package available on the RDM website
- Through legacy front end panels on 485 networks
- Through the RDM Data Director.

Set-up Mode

Set-up through front buttons

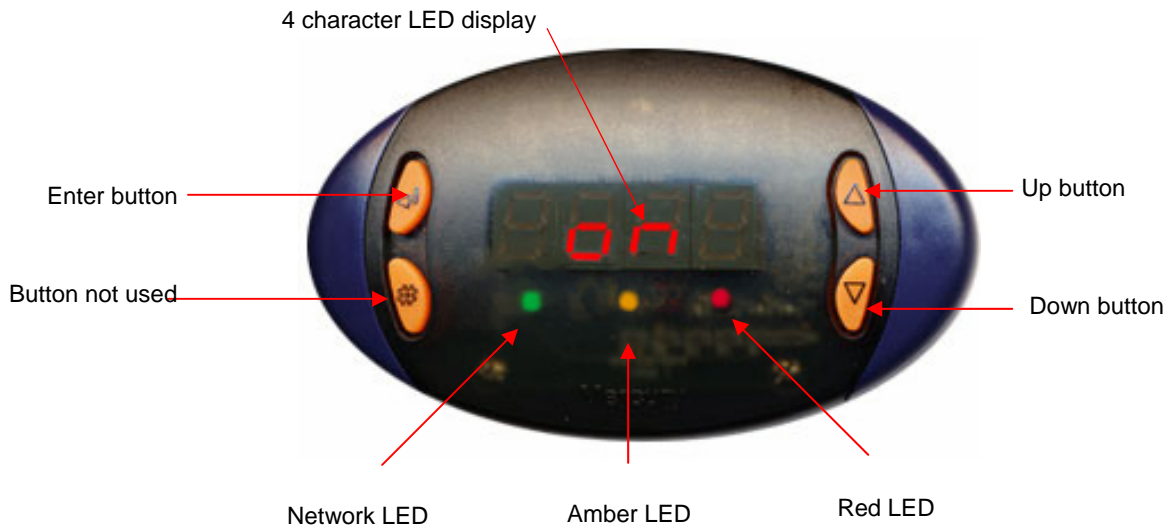

To enter set-up mode, hold the Enter and Down buttons together for approximately 3 seconds until the message “Ent” appears on the display. Now press the Enter button again to enter the function menu. IO will be displayed. Scroll up or down to go through the list.

Set-up Function Menu

Display	Option	Explained in Paragraph
IO	View Input/Output States	View Input/Output States
PArA	Set/view Parameters	Set/view parameters
rtc	Set/view Clock (rtc = Real Time Clock)	Real Time Clock
nEt	Set/view network configuration	Network Configuration
SoFt	View software version	
ESC	Escape back to normal operation	



Ensure that all power is switched off before installing or maintaining this product

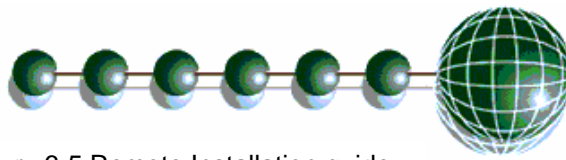

Recommended set-up method

If you are not connecting to a network and want to set up the controller through the buttons we recommend you use the following order from the function menu.

rtc. Real time clock (This will automatically synchronise on network systems)

- a. Use the up or down buttons to scroll through the display until the display reads “rtc”
- b. Press enter. The display will show “t-1”. press enter again
- c. Scroll hours up or down (0 – 23) press enter
- d. Use up button to select “t-2”, press enter
- e. Scroll minutes up or down (0 – 59) press enter
- f. Repeat for t-3 (seconds 0 – 59)
- g. Repeat for t -4 (Days up to 31)
- h. Repeat for t -5 (months up to 12)
- i. Repeat for t -6 (Year up to 99)
- j. Use up button to display “ESC”, press enter to display “rtc”

Time clock is now set

PArA. Set/view parameters (This can be achieved at the network front end)

- a. From the function menu scroll to select PArA
- b. Pressing Enter while PArA is displayed will enter the parameter menu. The first parameter option will be displayed as P-01. Pressing the Up or Down button will present the other parameter options P-02, P-03 etc. See the parameter list below to find what parameter number corresponds to which actual parameter. Pressing the Enter button will show the current value of the selected parameter. Press Up or Down to modify the value and press Enter again to save the value. The parameter list number will be displayed again. Two other options are present in the parameter menu – dFLt and ESC. Selecting ESC will exit setup mode. Selecting dFLt will reset all parameters back to the default values for the current type of controller.

**Parameter Table:
Parameter table for I/O Module**

Number	Parameter	Range	Step	Units	Default	Comments
P-01	Input Type Channel 1	0 = Probe 1 = Plant N/C 2 = Plant N/O	1	Degrees N/A N/A	0	
P-11	Input Type Channel 2	0 = Probe 1 = Plant N/C 2 = Plant N/O	1	Degrees N/A N/A	0	
P-21	Input Type Channel 3	0 = Probe 1 = Plant N/C 2 = Plant N/O	1	Degrees N/A N/A	0	
P-31	Input Type Channel 4	0 = Probe 1 = Plant N/C 2 = Plant N/O	1	Degrees N/A N/A	0	
P-41	Input Type Channel 5	0 = Probe 1 = Plant N/C 2 = Plant N/O	1	Degrees N/A N/A	0	
P-51	Input Type Channel 6	0 = Probe 1 = Plant N/C 2 = Plant N/O	1	Degrees N/A N/A	0	



Ensure that all power is switched off before installing or maintaining this product

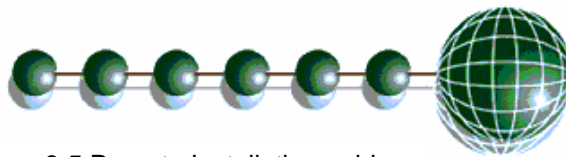

Network Configuration

The final section to set-up is the network address. In all instances, this must be done before the controller is plugged into the site network. The controllers have an auto-initialise function, which will automatically log the device onto the site network. If the wrong address has been entered onto the network, you will have to reset the controller address by setting the address to 00-0, and then re-enter the correct address. (You may have to deregister the wrong address from the home system as well).

To set the controller onto a network you must first connect the controller to a communications module. This is either a: -

- 485 Legacy, or
- IP Futura

485 Legacy module

- This product supports Genus compatible network protocol

Connecting a 485 legacy module to the controller will determine which set up screens are made available. Note: °F values are not supported on a RS485 network system.

Display	Option
485t	485 Network Type
485A	485 Address/Name
gAdd	Show underlying network address assigned to controller
rLog	Re-log the controller back onto the network
CLrA	Clear the address/name from the controller
ESC	Exit network menu. N.B. this option must be selected to save any changes made in this menu

The 485A option shows a value representing either the name of the controller in a Genus compatible network.

If the controller is set for Genus compatible then the value shown is of the form 05-6. This means the controller would try to log onto a Genus compatible network using the name 'RC05-6'.

The following options are only available when the network type is set to Genus compatible.

The gAdd option displays (in hexadecimal format) the underlying network address assigned to the controller when it was logged onto the network.

The rLog option allows the controller to be logged back onto the network with its current name. The 'rLog' message will flash for confirmation. Press the Enter button to execute the command, Up or Down buttons to cancel.



Ensure that all power is switched off before installing or maintaining this product

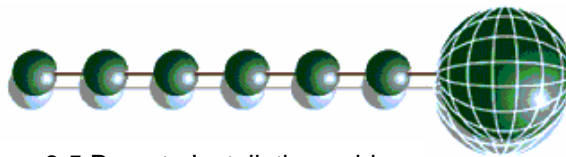

Fast Network Address Reset

The CLrA option will clear out the network address and name in the controller. The 'ClrA' message will flash for confirmation. Press the Enter button to execute the command, Up or Down buttons to cancel.

To enter this mode, hold the Enter, Up and Down buttons together for approximately 3 seconds until the message CLrA appears on the display. CLrA is the first option in the menu consisting of the following options:

Display	Option
CLrA	Clear the address/name from the controller
ESC	Exit Setup mode

Pressing the Enter button to select the CLrA option will cause the 'CLrA' message to flash for confirmation, if the network type is set to Genus compatible. Press the Enter button to execute the command, Up or Down buttons to cancel. If the network type is not set to Genus compatible then the CLrA message will not flash and the ESC option can be used to exit the menu.

IP Futura module

In an IP system there are two options

- IP-L
- IP-r

IP-L allows you to fix an IP address into the controller, which you would use when you are connecting the controllers onto a customer's local area network. This would allow the customer to view each controller using Internet Explorer.

IP-r allows you to give each controller on the system a unique number. This number is then allocated a dynamic IP address by the system DHCP server (such as the RDM Data Director)

IP-L

To configure the communication module for IP-L, set all three rotary switches to zero. The module should then be connected to the controller.

1. nEt. From the function menu you can now select nEt
 - Press enter and the display will show "IP-L", press enter
 - You can now set the address using the table below

Display	Option
IP-1	IP Address byte 1
IP-2	IP Address byte 2
IP-3	IP Address byte 3
IP-4	IP Address byte 4
nL	Network Mask Length
gt-1	Gateway Address byte 1
gt-2	Gateway Address byte 2
gt-3	Gateway Address byte 3
gt-4	Gateway Address byte 4
ESC	Exit network menu. N.B. this option must be selected to save any changes made in this menu



Ensure that all power is switched off before installing or maintaining this product

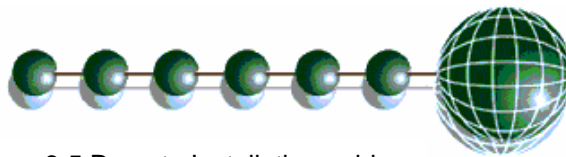

IP-r

To configure the communication module for IP-r, set the three rotary switches to give each controller a unique identifier. The module should then be connected to the controller and the network.

The green network LED on the controller will flash until it has been logged on to the network. The Green network LED will remain permanently on while it is on-line.

Normal Operation

During normal operation, the controller will display "on". If the Timer is on a network and on-line, the green network LED will be on.



The Network green LED flashes if the controller goes off-line or loses its given address.

Viewing

Apart from setting up the controller, you can also view the status of the inputs and outputs.

1. IO. View Inputs / Outputs and States
 - a. From the function menu, select "IO", press enter
 - b. You can now scroll through the IO tables as set out below. The tables you view will depend on the controller type configuration.

Input/Output table for Remote Module

Number	IO	Range	Step	Units
I-01	Input 1			
I-02	Input 2			
I-03	Input 3			
I-04	Input 4			
I-05	Input 5			
O-01	Relay 1	0 = off, 1 = on	N/A	N/A
O-02	Relay 2	0 = off, 1 = on	N/A	N/A
O-03	Relay 3	0 = off, 1 = on	N/A	N/A
O-04	Relay 4	0 = off, 1 = on	N/A	N/A
O-05	Relay 5	0 = off, 1 = on	N/A	N/A

Display Messages

The following messages can appear on the Mercury display.

Display	System status
on	Controller On



Ensure that all power is switched off before installing or maintaining this product

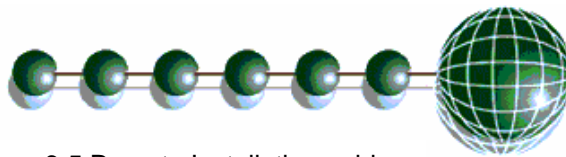

Remote Commands

Values for analogue input block values:	Probe 1	<i>returns probe 1 value</i>
	Probe 2	<i>returns probe 2 value</i>
	Probe 3	<i>returns probe 3 value</i>
	Probe 4	<i>returns probe 4 value</i>
	Probe 5	<i>returns probe 5 value</i>
	Probe 6	<i>returns probe 6 value</i>
Values for Digital Input (Plant) fault values:	Plant 1	<i>returns Plant 1 status</i>
	Plant 2	<i>returns Plant 2 status</i>
	Plant 3	<i>returns Plant 3 status</i>
	Plant 4	<i>returns Plant 4 status</i>
	Plant 5	<i>returns Plant 5 status</i>
	Plant 6	<i>returns Plant 6 status</i>
Values for digital input (switch) values:	Switch 1	<i>returns Switch 1 status</i>
	Switch 2	<i>returns Switch 2 status</i>
	Switch 3	<i>returns Switch 3 status</i>
	Switch 4	<i>returns Switch 4 status</i>
	Switch 5	<i>returns Switch 5 status</i>
	Switch 6	<i>returns Switch 6 status</i>
Sent to values "Control State"	0 for Normal	
	1 for Amber (defrost) LED	
	2 for Red (alarm) LED	
	3 for Amber and Red LED's on	
Values for Digital Output values	Remote Relay 1	<i>controls relay 1</i>
	Remote Relay 2	<i>controls relay 2</i>
	Remote Relay 3	<i>controls relay 3</i>
	Remote Relay 4	<i>controls relay 4</i>
	Remote Relay 5	<i>controls relay 5</i>



Ensure that all power is switched off before installing or maintaining this product

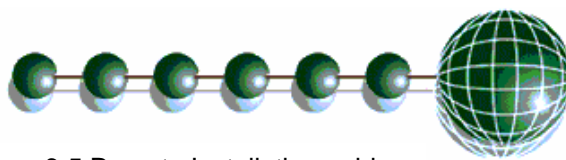

Specification

Power requirements:

Supply Voltage Range:	10 Vdc to 35 Vdc or 15 Vac to 30 Vac
AC Supply Frequency:	50 - 60 Hz \pm 10%
Maximum supply current:	1 Amp (Controller only)
Typical supply current:	<1.0 Amp (Controller only)
Operating temperature range:	+5°C to +50°C
Operating Humidity:	80% maximum
Storage temperature range:	-20°C to +65°C
Environmental:	Indoor use at altitudes up to 2000m, Pollution Degree 1, Installation Category II. Voltage fluctuations not to exceed \pm 10% of nominal voltage
Size:	110mm (W) x 60mm (H) x 100mm (D)
Weight:	150 Grams
Safety:	EN61010
EMC:	EN61326; 1997 +Amdt. A1; 1998
Ventilation:	There is no requirement for forced cooling ventilation
Class 2 Insulation:	No protective Earth is required

Relays

Max current relay 1:	6A (non inductive)
Max Voltage relay 1:	260Vac (external supply)
Max current relay 2:	3A (non inductive)
Max Voltage relay 2:	260Vac (external supply)
Max current relay 3:	3A (non inductive)
Max Voltage relay 3:	260Vac (external supply)
Max current relay 4:	3A (non inductive)
Max Voltage relay 4:	260Vac (Internal supply)
Max current relay 5:	3A (non inductive)
Max Voltage relay 5:	260Vac (Internal supply)



Ensure that all power is switched off before installing or maintaining this product

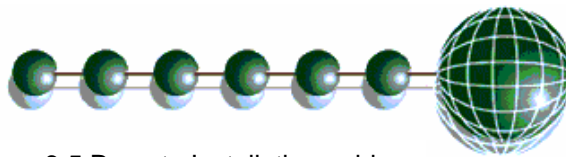

Inputs:

Input resistance: 3.01K Ohms (for PTC or NTC type probes)
Input type PT1000 for all versions

Comms: RS232 with flow control

Installation:

Panel Cut-out:

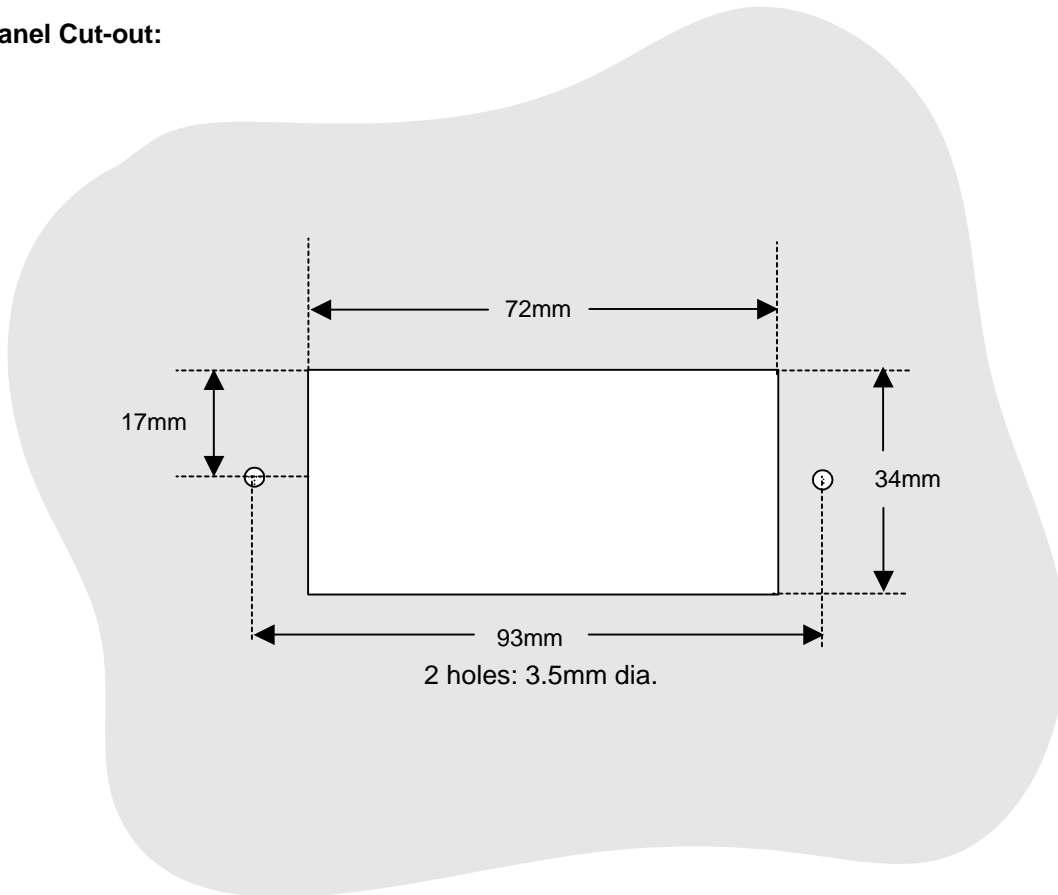

Fixing:

The controller can be fixed either by 2 X M3 screws from the rear or by the plastic retaining device (PR0329), obtainable from RDM.

Clearances:

The controller must have 5mm clearance above the top and below bottom, and 25mm clearance from the sides. Clearance at the rear is dependant on the wiring. There is no requirement for forced cooling ventilation

Cleaning:

Do not wet the controller when cleaning. Clean the front by wiping with slightly dampened lint free cloth.



Ensure that all power is switched off before installing or maintaining this product

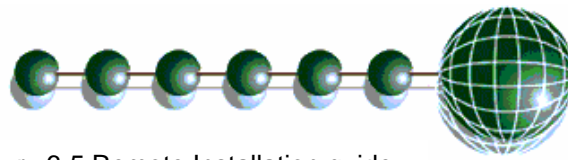

Appendix 1

Using the I/O module with the Data Builder (Controller Editor) Program

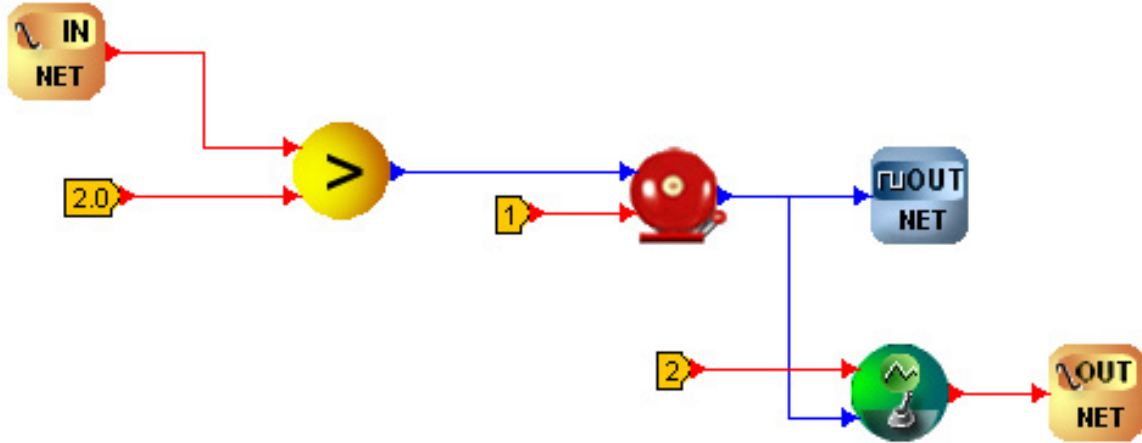

The above diagram shows how the I/O module can be used as a simple over temperature alarm with relay. The “analogue in” block has its value “mapped” to one of the I/O module probes. The probe value is compared with a set-point, which when over the set-point causes the output to be true. This is connected to an alarm block which alarms after the preset delay of 1 minutes. The “digital out” block is “mapped” to one of the I/O modules relays. The alarm LED on the I/O module is brought on by sending the value 2 to the I/O module “Control State”

Analogue Input block properties:

Set Units →

Set Type to Network →

Set Device to I/O module name →

Set Value to Probe number →

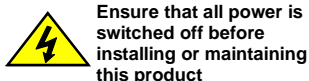

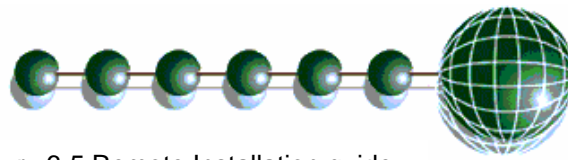

Digital Output Block properties

- Set Type to Network →
- Set Device to I/O module name →
- Set Value to Remote Relay *number* →

Digital Output 1 ✖

Name Internal

Output Mapping

Type ▼

Device:

Value:

Note: Fixed outputs are only selectable if they do not conflict with DM / DD settings and are not being used by another IO block

Java Applet Window

Analogue Output Block properties

- Set Type to Network →
- Set Device to I/O module name →
- Set Value to Control State →

Analog Output 1 ✖

Name

Units ▼ Internal

Output Mapping

Type ▼

Device:

Value:

Note: Fixed outputs are only selectable if they do not conflict with DM / DD settings and are not being used by another IO block

Java Applet Window

Control State Values: -

- 0 = no LED's on
- 1 = Amber (defrost) LED on
- 2 = Red (Alarm) LED on
- 3 = Amber & Red LED's on



Ensure that all power is switched off before installing or maintaining this product